



RWF40... Compact Universal Controllers

optimized for temperature and pressure control in connection with modulating or multistage burners

User Manual

The RWF40... controller and this User Manual are intended for use by OEMs which integrate the controller into their products!

Contents

1.	Introduction	6
1.1	General notes.....	6
1.2	Description	6
1.3	Typographical conventions	7
1.3.1	Warning symbols	7
1.3.2	Notification symbols.....	7
1.3.3	Presentation.....	7
2.	Type of unit	8
2.1	Type field	8
3.	Installation	9
3.1	Installation site and climatic conditions	9
3.2	Dimensions	9
3.3	Side-by-side mounting	10
3.4	Mounting in a panel cutout.....	10
3.5	Cleaning the front.....	11
3.6	Removing the controller module.....	11
4.	Electrical connections	12
4.1	Installation notes	12
4.2	Block diagram	13
4.3	Assignment of terminals.....	14
4.4	Galvanic separation.....	17
5.	Operating modes.....	18
5.1	Low-fire operation	18
5.2	High-fire operation.....	18
5.2.1	Modulating burner, floating output	18
5.2.2	Modulating burner, analog output.....	19
5.2.3	2-stage burner, floating output.....	19
5.2.4	2-stage burner, analog output.....	20
5.3	Safety shutdown	20
5.4	Predefined setpoint	20
5.4.1	Setpoint changeover «SP1 / SP2», analog setpoint shift	21
5.4.2	Setpoint changeover «SP1» / external setpoint.....	22
5.4.3	Setpoint «SP1», analog / binary setpoint shift	23
5.4.4	External setpoint, binary setpoint shift	24
5.5	Weather-dependent setpoint shift	25
5.5.1	Heating curve slope	26
5.6	Response threshold «Q»	27
5.7	Cold start of plant.....	28

6.	Operation	29
6.1	Basic display	30
6.1.1	Meaning of the display and buttons	30
6.2	User level	31
6.2.1	Changing the setpoints	31
6.2.2	Manual operation of a modulating burner	33
6.2.3	Manual operation of a 2-stage burner	33
6.2.4	Start self-setting	34
6.2.5	Display of the software version and of unit of actual value	34
6.3	Parameter level.....	35
6.3.1	Entering parameters.....	35
6.4	Configuration level.....	35
6.4.1	Changing the configuration code	35
7.	Parameter settings	36
8.	Configuration	38
8.1	C111 inputs	38
8.2	C112 limit comparator, controller type, setpoint «SP1», locking.....	40
8.3	C113 unit address, dimensional unit, out-of-range.....	44
8.3.1	SCL scaling of standard signal range start, analog input 1	45
8.3.2	SCH scaling of standard signal range end, analog input 1	45
8.3.3	SCL2 scaling of standard signal range start, analog input 2.....	45
8.3.4	SCH2 scaling of standard signal range end, analog input 2.....	46
8.3.5	SPL lower setpoint limit	46
8.3.6	SPH upper setpoint limit.....	46
8.3.7	OFF1 actual value correction for analog input 1	46
8.3.8	OFF2 actual value correction for analog input 2	46
8.3.9	OFF3 actual value correction for analog input 3	46
8.3.10	dF1 2nd order digital filter for analog input 1.....	46
8.3.11	dF3 1st order digital filter for analog input 3 (only with RWF40.0X2B97).....	46
8.3.12	oLLo lower working range limit (only with RWF40.0X2B97)	47
8.3.13	oLHi upper working range limit (only with RWF40.0X2B97).....	47
8.3.14	dtT bus watchdog timer for remote operation (only with RWF40.0X2B97)	47
9.	Self-setting function	48
9.1	Self-setting function in high-fire operation	48
9.2	Checking the controller parameters.....	50
10.	What to do if...	51
10.1	...numbers are flashing on the display.....	51

11.	Technical data	52
11.1	Inputs	52
11.1.1	Analog input 1 (actual value)	52
11.1.2	Analog input 2 (external setpoint, setpoint shift)	52
11.1.3	Analog input 3 (outside temperature)	53
11.1.4	Binary input «D1»	53
11.1.5	Binary input «D2»	53
11.2	Outputs	53
11.2.1	Output 1 (release of burner)	53
11.2.2	Output 2, 3 (floating output)	53
11.2.3	Output 4 (limit comparator)	53
11.2.4	Output 5, analog output (option)	54
11.2.5	Transducer supply	54
11.2.6	Interface RS-485 (optional)	54
11.3	General ratings	54
11.3.1	Measuring accuracy	55
11.3.2	Monitoring of measuring circuit	55
11.3.3	Environmental conditions	55
12.	Current settings	56
12.1	Process data	56
12.2	Parameter level	56
12.3	Configuration level	57

1.1 General notes



Please read this User Manual before switching on the controller. Keep the User Manual in a safe place which can be accessed by all users at all times. Please help us improve the information given in the User Manual. Your suggestions will be welcome.



All necessary settings and, where required, the settings to be made inside the unit, are described in this User Manual (applicable to controller software version 126.01.02 and 126.02.01).

⇒ Section 6.2.5 «Display software version and dimensional unit»

Should any problems arise during commissioning, do not make any unauthorized manipulations on the unit. You could endanger your rights under the warranty terms! Please contact us in such a case.



When returning modules, assemblies or components to HVAC Products, the regulations as per DIN EN 100 015 «Protection of electrostatically sensitive devices» must be observed. Always use the appropriate **ESD** packaging for transport.

Please take note that we cannot assume liability for damage caused by ESD.

ESD = electrostatic discharge

1.2 Description

Use

The RWF40... is used primarily for the control of temperature or pressure in oil- or gas-fired heating plants. It is a compact modulating controller without position feedback acting on the burner. An external switch can be used to change it to a 2-position controller for the control of 2-stage burners. The integrated thermostat function switches the burner on and off. The thermostat (relay output 1) can be used as a thermal reset limit thermostat conforming to DIN 3440. An adjustable response threshold is used to switch to a higher burner output (high-fire operation).

Control

In modulating operation, the RWF40... operates as a PID controller.

In 2-stage operation, the RWF40... provides control based on the set switching threshold. The setpoint of the RWF40... can be adjusted either on the controller itself or externally. Minimum and maximum setpoint limits can be adjusted. A self-setting function is provided as a standard feature.

The plug-in controller module measures 96 x 48 x 127.5 mm and is especially suited for mounting in control panels. The controller features two 4-digit 7-segment displays for the actual value (red) and the setpoint (green). A limit comparator is also provided; its switching characteristic can be set on the configuration level.

A choice of 8 different limit comparator functions is available.

Options

An RS-485 interface is provided for integrating the controller into a data network. Output 5 can be used as an analog output for modulating or 2-stage operation.

All connections are made via screw terminals at the rear of the unit.

1.3 Typographical conventions

1.3.1 Warning symbols

The signs for **Danger** and **Caution** are used in this User Manual under the following conditions:



Danger

This symbol is used where there may be a **danger to staff** if the instructions are disregarded or not strictly observed!



Caution

This symbol is used where there may be **damage to equipment or data** if the instructions are disregarded or not strictly observed!



Caution

This symbol is used if **precautionary measures must be taken** in handling electrostatically sensitive components.

1.3.2 Notification symbols



Note

This symbol is used to draw your **special attention** to a remark.



Reference

This symbol refers to **additional information** in other Manuals, chapters or sections.

abc¹

Footnote

Footnotes are **comments, referring to specific parts of the text**. They consist of 2 parts:

- 1) The **markings** in the text are arranged as continuous superscript numbers
- 2) The **footnote text** is placed at the bottom of the page and starts with a number and a period

*

Action

This symbol indicates that a **required action** is described.

The individual steps are indicated by an asterisk, e.g.:

* Press the ▲ button

1.3.3 Presentation

PGM

Buttons

Buttons are shown in a box. Either symbols or text are possible. If a button has multiple assignments, the text shown is always the one that corresponds to the function currently used.

EXIT

+ ▲

Button combinations

The representation of buttons combined with a plus sign means that, first; the  button must be kept depressed before pressing the other button.

2.1 Type field

Location The type field is glued onto the housing. The type designation consists of operating voltage and type reference of the unit.

Types

Type of unit	Description
RWF40.000A97 RWF40.010A97 ¹ .	Basic version with floating output
RWF40.001A97 RWF40.011A97 ¹ .	With additional analog output
RWF40.002B97	With additional analog output and RS-485 interface

¹. Packaging variants



The power supply must agree with the operating voltage given on the type field.

Factory setting

The measured value range and the analog inputs are factory-set.

⇒ Chapter 8 «Configuration»

Accessories

Adapter frame ARG40 for plants where the RWF32... predecessor model was used (for conversion to RWF40...).

Bracket ARG41 for mounting the RWF40... on 35 mm DIN rails conforming to DIN 46277.

Dummy cover AVA10.200/109 for covering control panel cutouts for the RWF40...

3.1 Installation site and climatic conditions

- The installation site should be free from vibrations, dust and corrosive media
- The controller should be installed away from sources of electromagnetic fields, such as variable speed drives or high-voltage ignition transformers

Relative humidity: $\leq 95\%$ (noncondensing)

Ambient temperature range: $-20\dots+50\text{ }^\circ\text{C}$

Storage temperature range: $-40\dots+70\text{ }^\circ\text{C}$

3.2 Dimensions

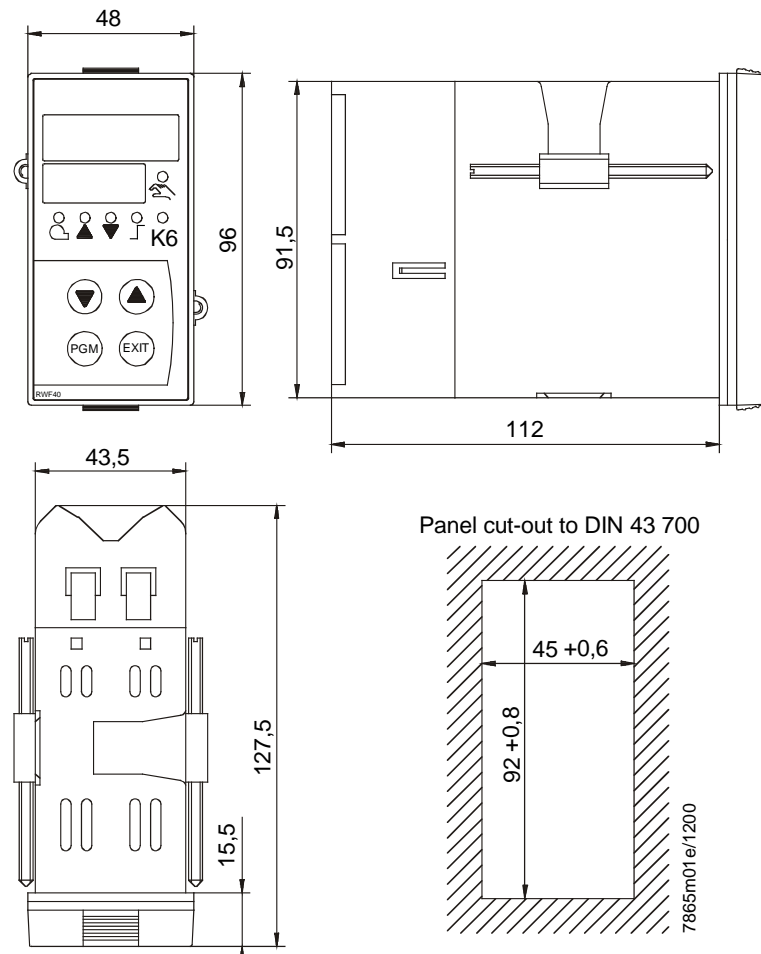

3.3 Side-by-side

If several controllers are mounted side-by-side or above one another in a control panel, minimum spacing must be observed: 30.5 mm vertically and 10.5 mm horizontally.

3.4 Mounting in a panel cutout

* Place the seal supplied with the unit onto the controller housing.



The unit must be installed with the seal so that no water or oil can penetrate the housing!

* Insert the controller from the front into the panel cutout.

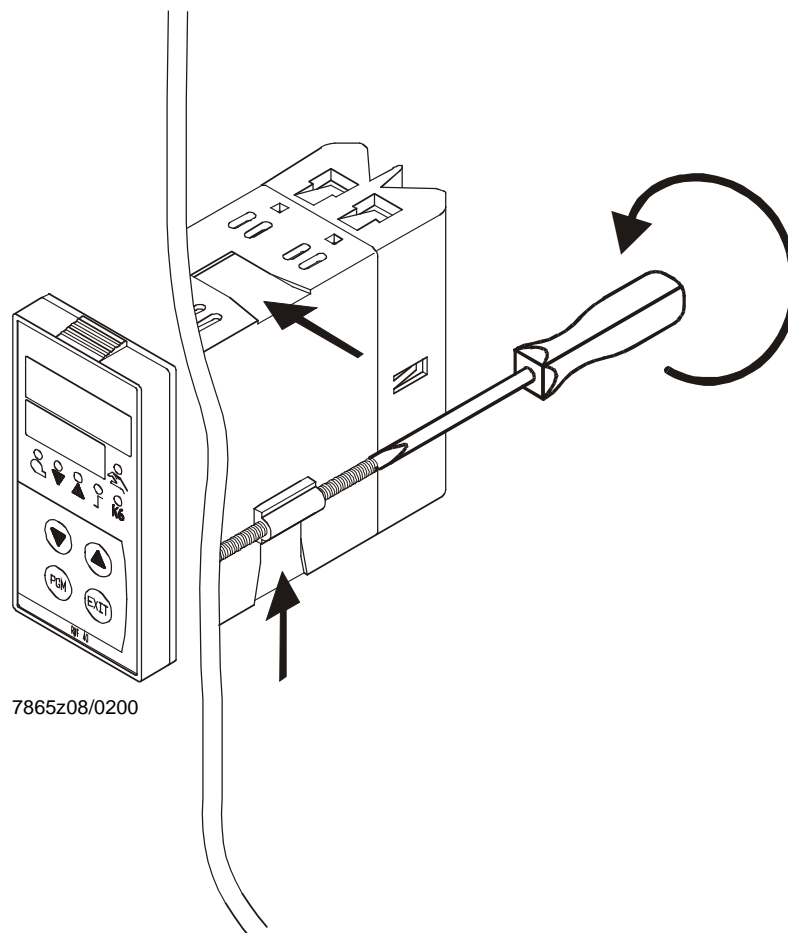

* At the rear of the panel, push the fixing elements into the guide slots from the side or top. The flat faces of the fixing elements must rest on the housing.

* Place the fixing elements against the rear of the panel and tighten them with a screwdriver.

3.5. Cleaning the front

The front can be cleaned with normal washing and rinsing agents or detergents.



The front is **not** resistant to corrosive acids, caustic solutions and abrasive cleaners. Do not clean with high-pressure cleaners!

3.6 Removing the controller module

The controller module can be removed from the housing for service.



The rules as per DIN EN 100 015 «Protection of electrostatically sensitive devices » must be observed for internal work on the controller! **No liability** will be assumed for damage caused by electrostatic discharge.

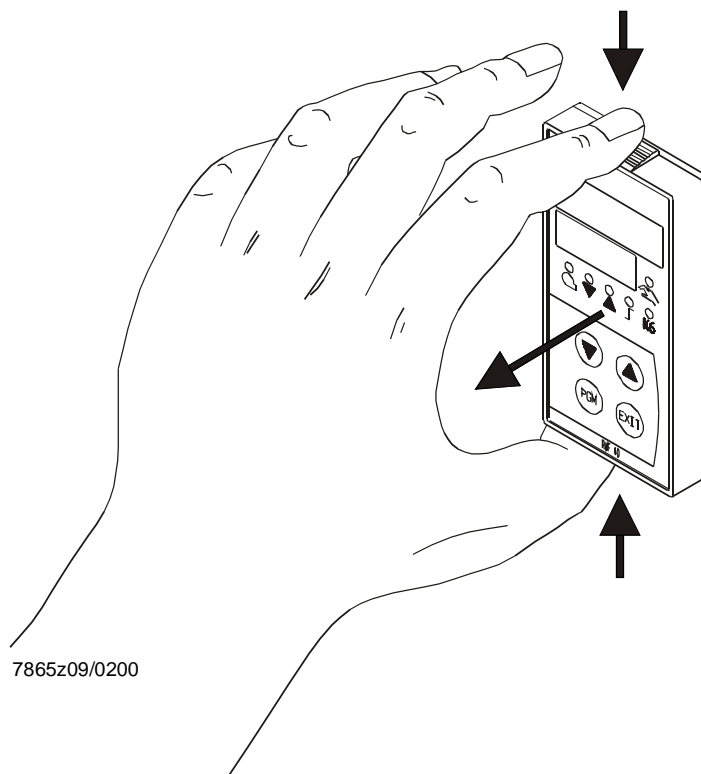

- * Press the ribbed surfaces together (at top and bottom) and pull out the controller module.

4.1 Installation notes

Safety regulations

- The choice of cable, installation and electrical connections of the controller must conform to VDE 0100 «Regulations for the installation of power circuits with nominal voltages below AC 1000 V», or the relevant local regulations
- The electrical connections must be made by qualified staff
- If contact with live parts is possible while working on the unit, the controller must be disconnected from the power supply (all-polar disconnection)

Fusing



- An internal current-limiting resistor cuts the supply voltage in the event of short-circuit. The external fusing should not be rated above 1 A (slow). The output relays must be fused for a maximum of 2 A to prevent contact welding in the event of a short-circuit in the load circuit

⇒ Section 11.2 «Outputs»

- No other loads may be connected to the controller's power supply terminals

Interference suppression

- The electromagnetic compatibility and interference suppression levels conform to the standards and regulations listed under «Technical data»

⇒ Chapter 11 «Technical data»

- Input, output and supply cables should be routed separately, not parallel to one another
- Arrange sensor and interface cables as twisted and shielded cables, and do not run them close to power cables or components. Ground the shielding to the controller **at one end** to the «PE» terminal
- Earth the «PE» terminal of the controller to protective earth. This cable must have a cross-sectional area that is at least as large as that of the supply cables. Earthing cables must be wired in a star configuration to a common earthing point connected to the protective earth of the supply. Earthing cables must not be looped from one controller to another

Incorrect use

- The unit is not suitable for installation in areas with an explosion hazard
- Incorrect settings on the controller (setpoint, data of parameter and configuration levels) can affect the proper functioning of the following process or lead to damage. Safety devices independent of the controller, such as overpressure relief valves or temperature limiters / monitors should therefore always be provided, and only be capable of adjustment by qualified staff. Please observe the relevant safety regulations. Since self-setting cannot be expected to handle all possible control loops, the stability of the resulting actual value should be checked
- The analog inputs of the controller must not exceed a maximum voltage of AC 30 V or DC 50 V against «PE»

⇒ Section 4.3 «Galvanic separation»

4.2 Block diagram

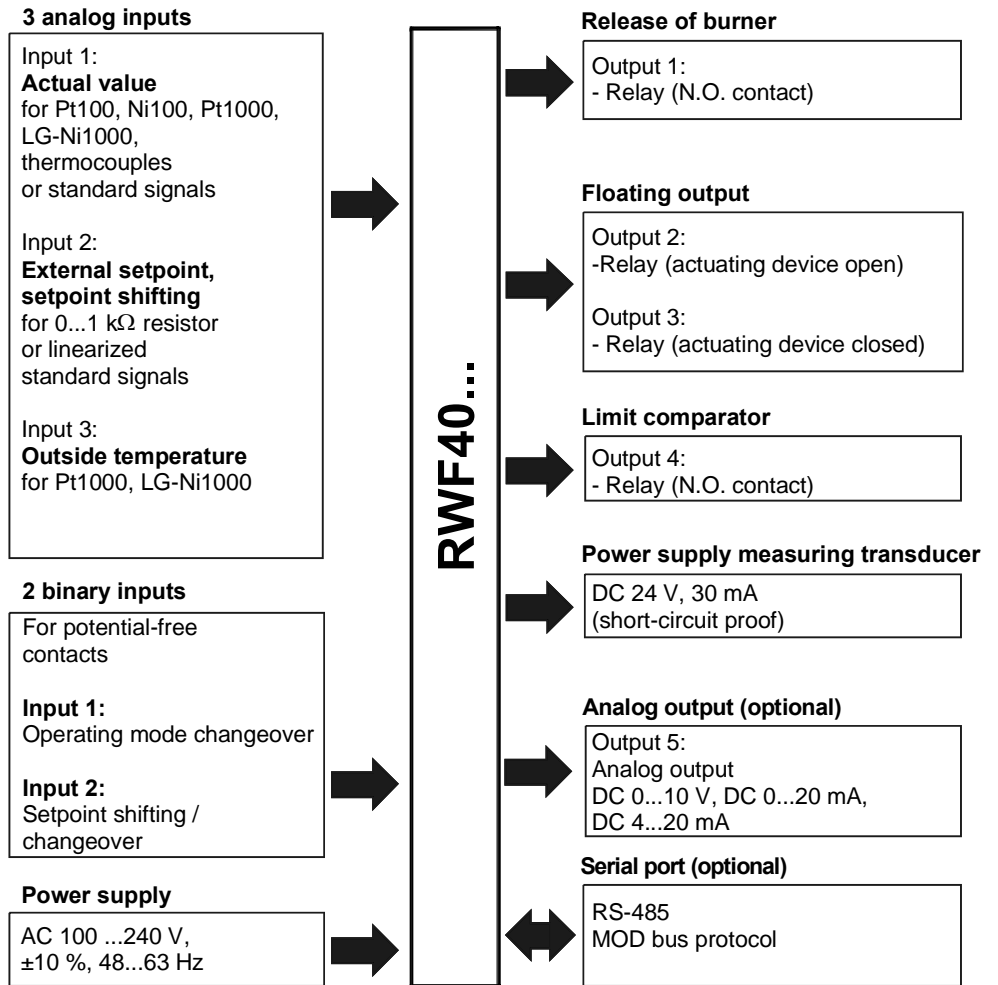

7865101e/0305

4. Electrical connections

4.3 Assignment of terminals



Electrical connections may only be made by qualified personnel!

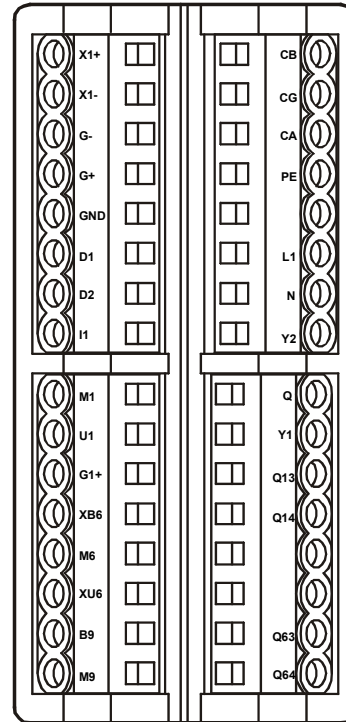

7865z07/0603

Outputs	Display LED	Terminal no.	Connection diagram
Relay 1: Release of burner Can be used as a thermal reset limit thermostat to DIN 3440 Contact protection: Varistor S07K275		Q14 pole Q13 N.O. contact	<p>7865a11/1199</p>
Relay 2: Actuating device opens Contact protection: RC unit	▲	Y1 N.O. contact Q common pole	<p>7865a16/1099</p>
Relay 3: Actuating device closes Contact protection: RC unit	▼	Y2 N.O. contact	<p>7865a15/1099</p>
Relay 4: Limit comparator Contact protection: Varistor S07K275	K6	Q64 pole Q63 N.O. contact	<p>7865a15/1099</p>
Analog output (optional) DC 0 (4)...20 mA, 0 (2)...10 V		X1+ X1-	<p>7865a17/1099</p>

4. Electrical connections

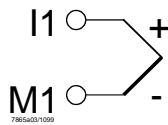
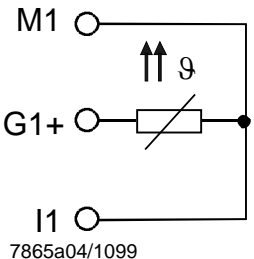
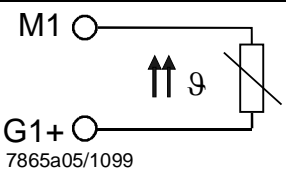
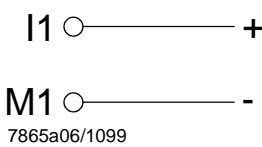
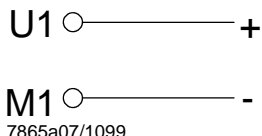
Analog input 1 (actual value)	Terminals	Connection diagram
Thermocouple	I1 M1	
Resistance thermometer in 3-wire circuit	M1 G1+ I1	
Resistance thermometer in 2-wire circuit, line compensation via offset correction (OFF1)	M1 G1+	
Current input DC 0...20 mA, 4...20 mA	I1 M1	
Voltage input DC 0...1 V, 0...10 V	U1 M1	

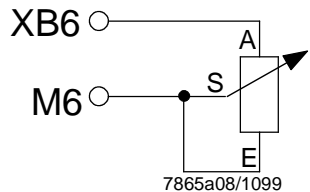
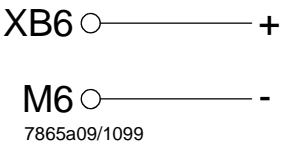
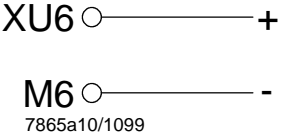
Analog input 2 (setpoint and setpoint shift)	Terminals	Connection diagram
Resistance potentiometer Offset correction (OFF2)	XB6 start M6 slider M6 end	
Current input DC 0...20 mA, 4...20 mA	XB6 M6	
Voltage input DC 0...1 V, 0...10 V	XU6 M6	

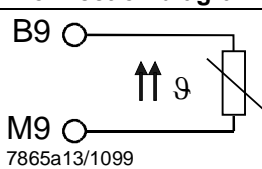
Analog input 3 (outside temperature)	Terminals	Connection diagram
Resistance thermometer in 2-wire circuit, line compensation via offset correction (OFF3)	B9 M9	

4. Electrical connections

Binary inputs	Terminals	Connection diagram
Operating mode selector ⇒ Section 5.2 «High-fire operation»	D1	<p>D1 ○ ————</p> <p>D2 ○ ————</p> <p>GND ○ ————</p> <p>7865a12/1099</p>
Setpoint shift / changeover ⇒ Sections 5.4.1...5.4.4	D2	
Common ground	GND	

Operating voltage, interface	Terminals	Connection diagram
Operating voltage AC 100...240 V ±10 %, 48...63 Hz	L1 live conductor	<p>L1 ○ ————</p> <p>N ○ ————</p> <p>PE ○ ————</p> <p>7865a18/0603</p>
Protective earth	N neutral conductor	
	PE	

Operating voltage for transducer	G+	<p>G+ ○ ———— +</p> <p>DC 24 V / 30 mA</p> <p>G- ○ ———— -</p> <p>7865a14/1099</p>
	G-	
Serial interface RS-485	CA CB CG	RxD / TxD+ RxD / TxD- GND

4.4 Galvanic separation

The diagram shows the maximum potential differences that may exist between the function modules in the controller.

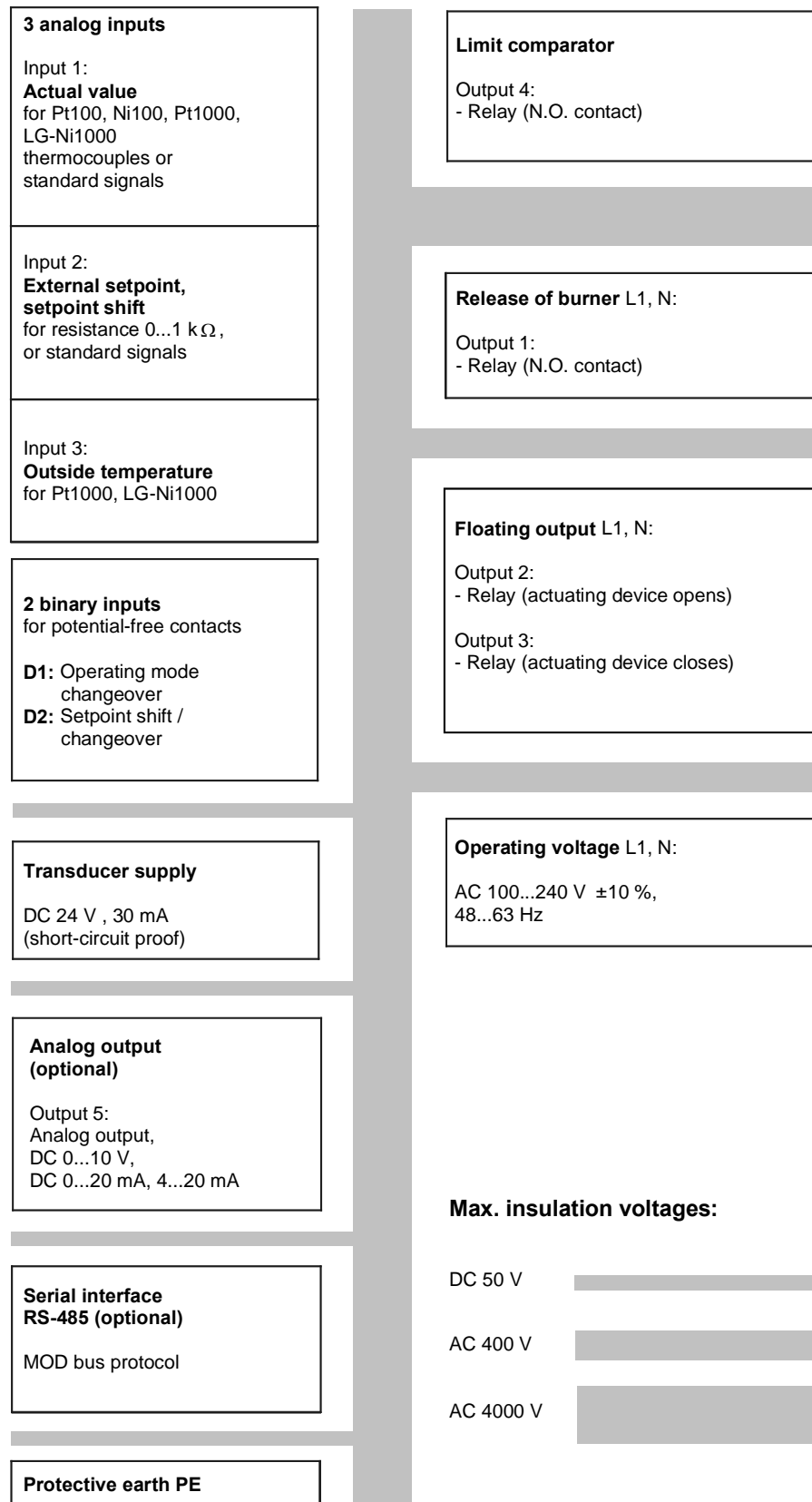

7865f07e/0305

5.1 Low-fire operation

Low-fire operation means that only small amounts of heat are drawn from the boiler. A 2-position controller maintains the setpoint, switching the burner on and off like a thermostat.

Thermostat function

This mode of control is known as the **thermostat function**. An adjustable switching differential ensures that the burner's switching frequency can be selected, aimed at reducing wear.

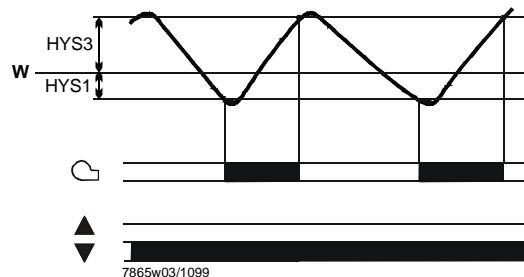

Modulating and 2-stage operation:

Actual value between «HYS1» and «HYS3»

5.2 High-fire operation

High-fire operation means that large amounts of heat are drawn from the boiler so that the burner is continuously running. If the heating load during thermostat operation rises to a level where the actual value begins to fall below the switch-on threshold «HYS1», the controller will not immediately switch to a higher burner output, but makes a dynamic test of the control deviation first and switches to the higher output only when an adjustable threshold «Q» is exceeded (A).

⇒ Section 5.6 «Response threshold Q»

Operating mode changeover

- In high-fire operation – depending on the application – the burner can be fired in **modulating** or **2-stage** operation, then burning larger amounts of fuel than in low-fire operation. The binary input «D1» can be used to switch between modulating and 2-stage operation
- When contact is open: Modulating burner operation
- When contact is closed: 2-stage burner operation

5.2.1 Modulating burner, floating output

In diagram area (1), the thermostat function is active. The modulating mode of burner operation is shown in area (2). In high-fire operation, a modulating controller acts on an actuator via relay 2 (open) and relay 3 (close).

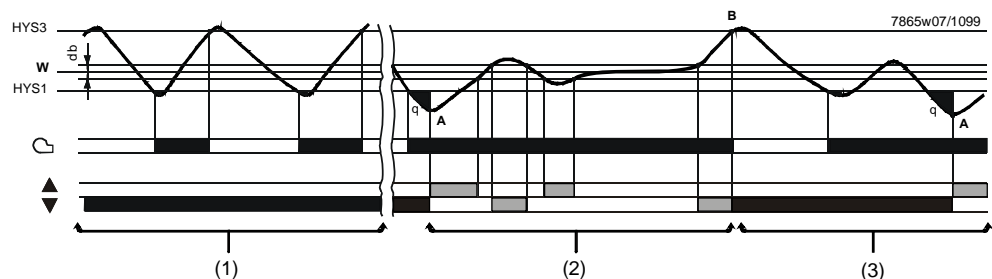

In area (3), the actual value exceeds the upper switch-off threshold «HYS3» and the controller switches the burner off (B). The controller only starts low-fire operation when the level falls below the switch-on threshold «HYS1» again. If «Q» is exceeded, the controller switches to high-fire operation (A).

⇒ Section 5.6 «Response threshold Q»

5.2.2 Modulating burner, analog output

In diagram area (1), the thermostat function is active.
 In area (2), the controller maintains the adjusted setpoint.

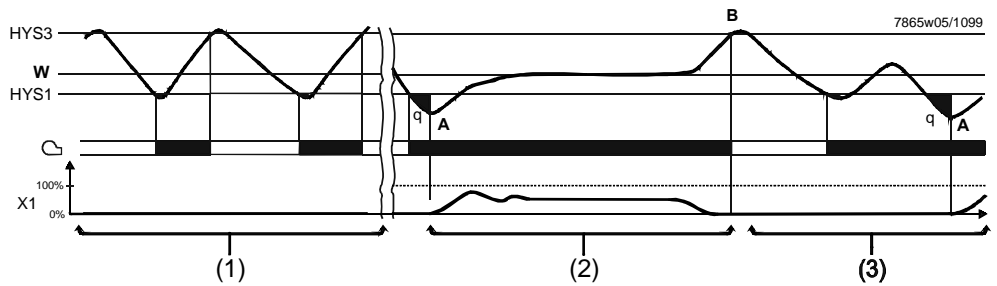

The positioning signal is delivered as a standard signal via the analog output.



The modulating controller must be available and configured in the unit (optional).

⇒ Section 8.2 «C112 limit comparator, controller type, setpoint «SP1», locking»

5.2.3 2-stage burner, floating output

In diagram area (1), the thermostat function is active.
 In area (2), a **2-position controller** acts on the second stage, via relay 2 (open) and relay 3 (close) by switching it into the circuit at the switch-on threshold «HYS1» / and out of circuit at the switch-off threshold «HYS2».

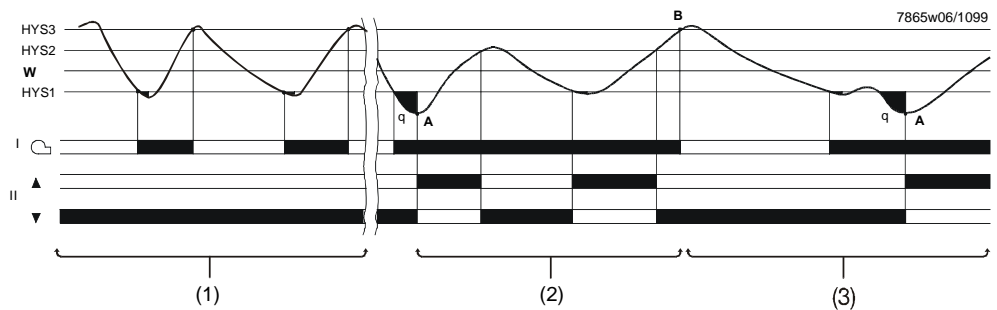

In area (3), the actual value exceeds the upper switch-off threshold «HYS3» and the controller shuts down the burner (B). The controller only starts low-fire operation when the level falls below the switch-on level «HYS1» again. If «Q» is exceeded, the controller switches to high-fire operation (A).

⇒ Section 5.6 «Response threshold Q»

5.2.4 2-stage burner, analog output

In this case, a standard binary signal switches the second stage into circuit with analog output «X1» on reaching the switch-on threshold «HYS1» and switches it out of circuit at the lower switch-off threshold «HYS2».

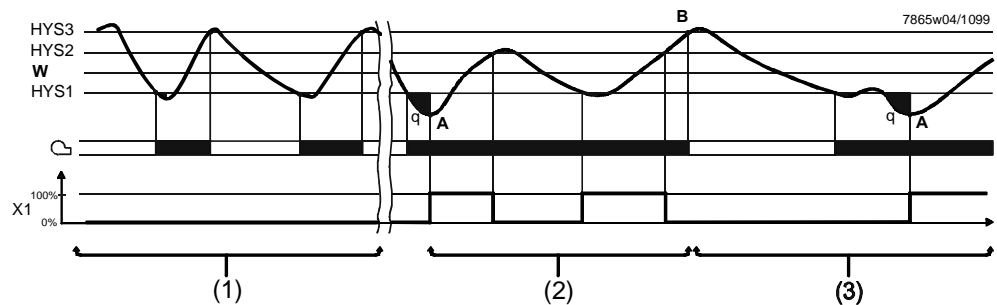

☞ The modulating controller must be available and configured in the unit (optional).

⇒ Section 8.2 «C112 limit comparator, controller type, setpoint «SP1», locking»

5.3 Safety shutdown

In the event of a sensor failure, the controller cannot monitor the actual value of the boiler temperature (analog input 1). Safety shutdown will automatically be triggered to guard against overheating.

This also applies to the acquisition of the external setpoint at analog input 2.

Functions

- Burner off
- Floating output for closing the actuating device
- Self-setting is ended
- Manual operation is ended

5.4 Predefined setpoint

The setpoint is preselected within preset limits using the buttons, an external analog signal or the interface.

It is possible to shift the setpoint, either by an analog or binary signal, to influence it according to the weather, or to change it via an external contact.

5.4.1 Setpoint changeover «SP1 / SP2», analog setpoint shift



C111 and C112 are described in chapter 8

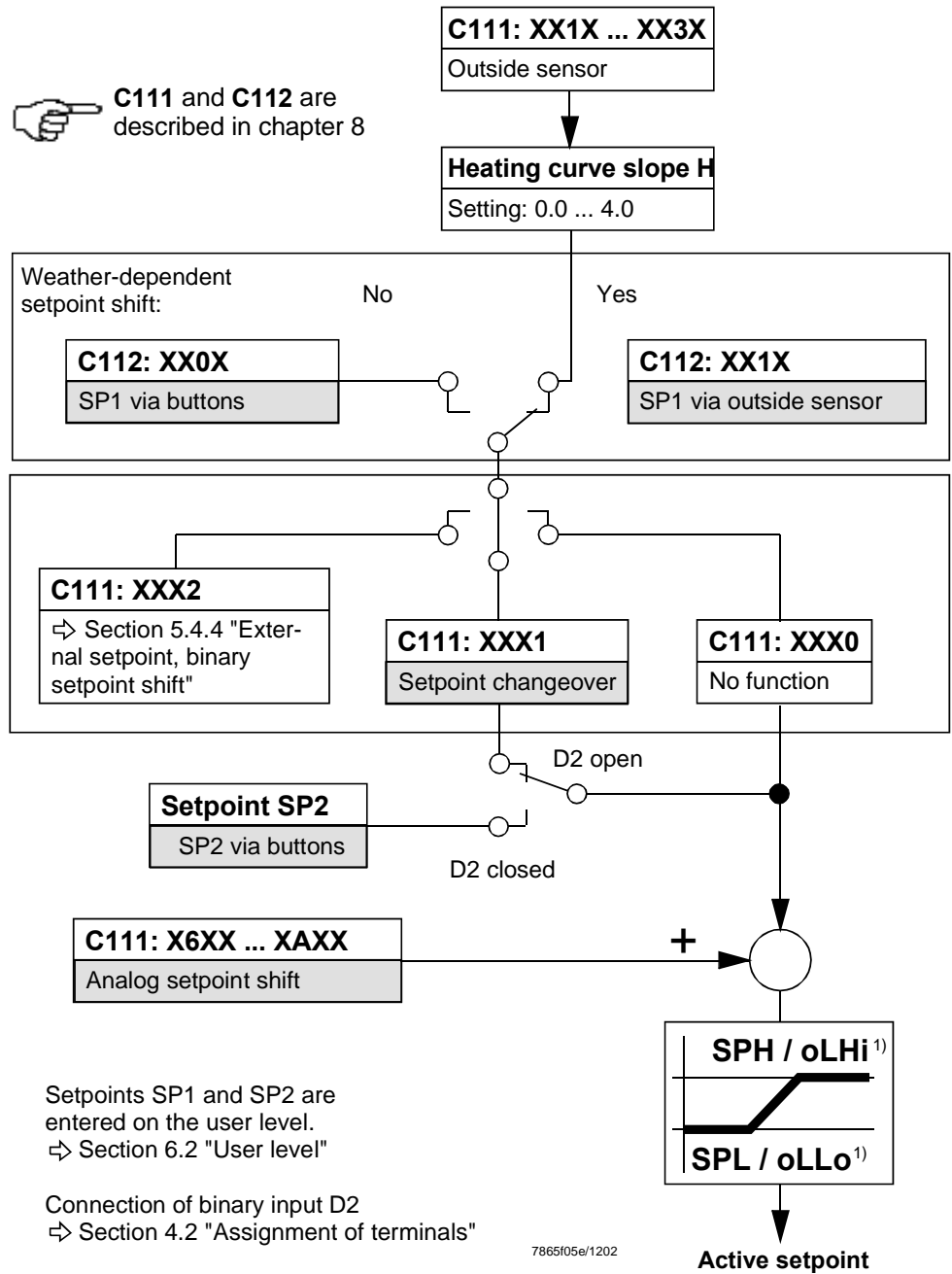

¹⁾ Only with RWF40.0X2B97

5.4.2 Setpoint changeover «SP1» / external setpoint

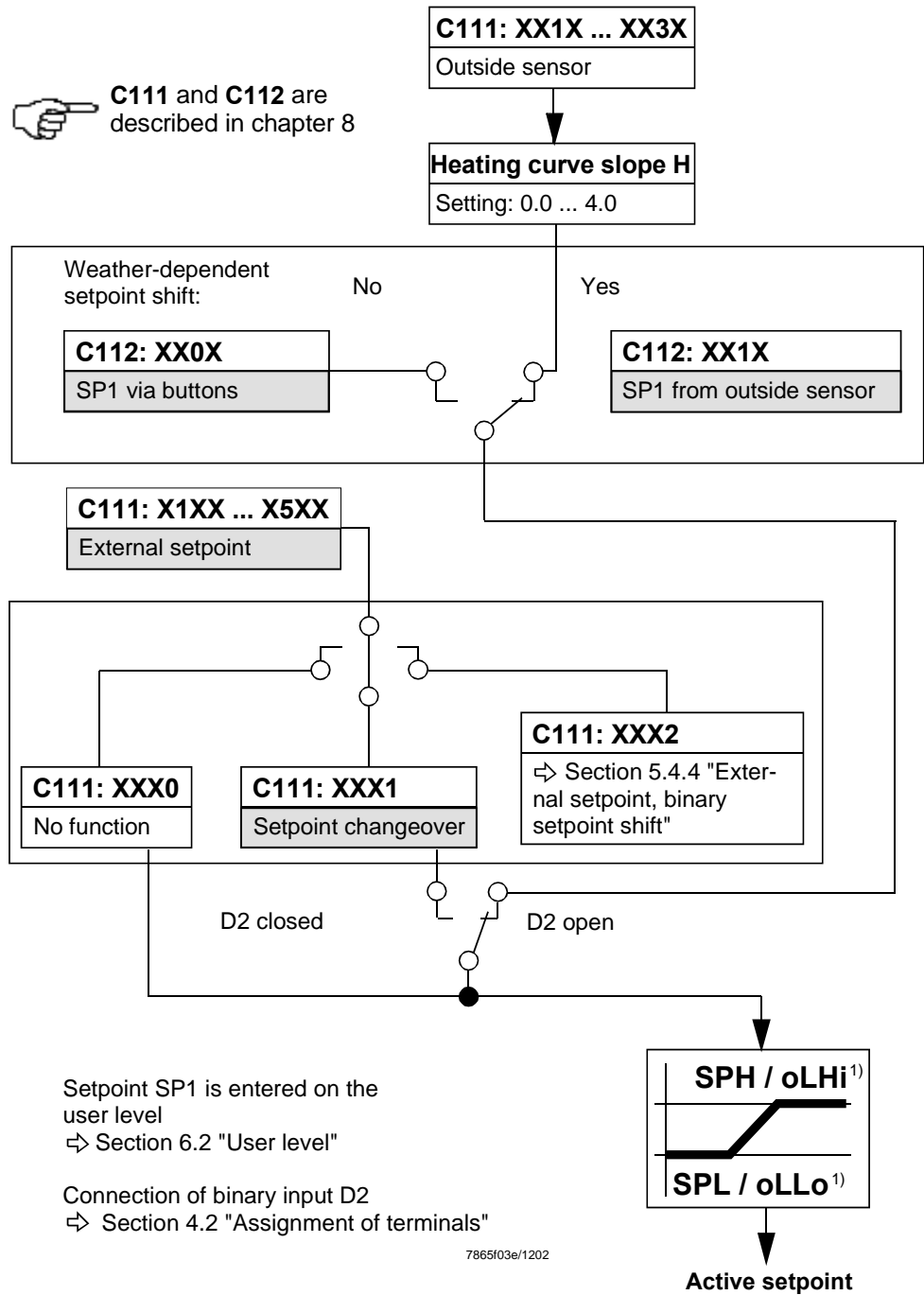

¹⁾ Only with RWF40.0X2B97

5.4.3 Setpoint «SP1», analog / binary setpoint shift



C111 and **C112** are described in chapter 8

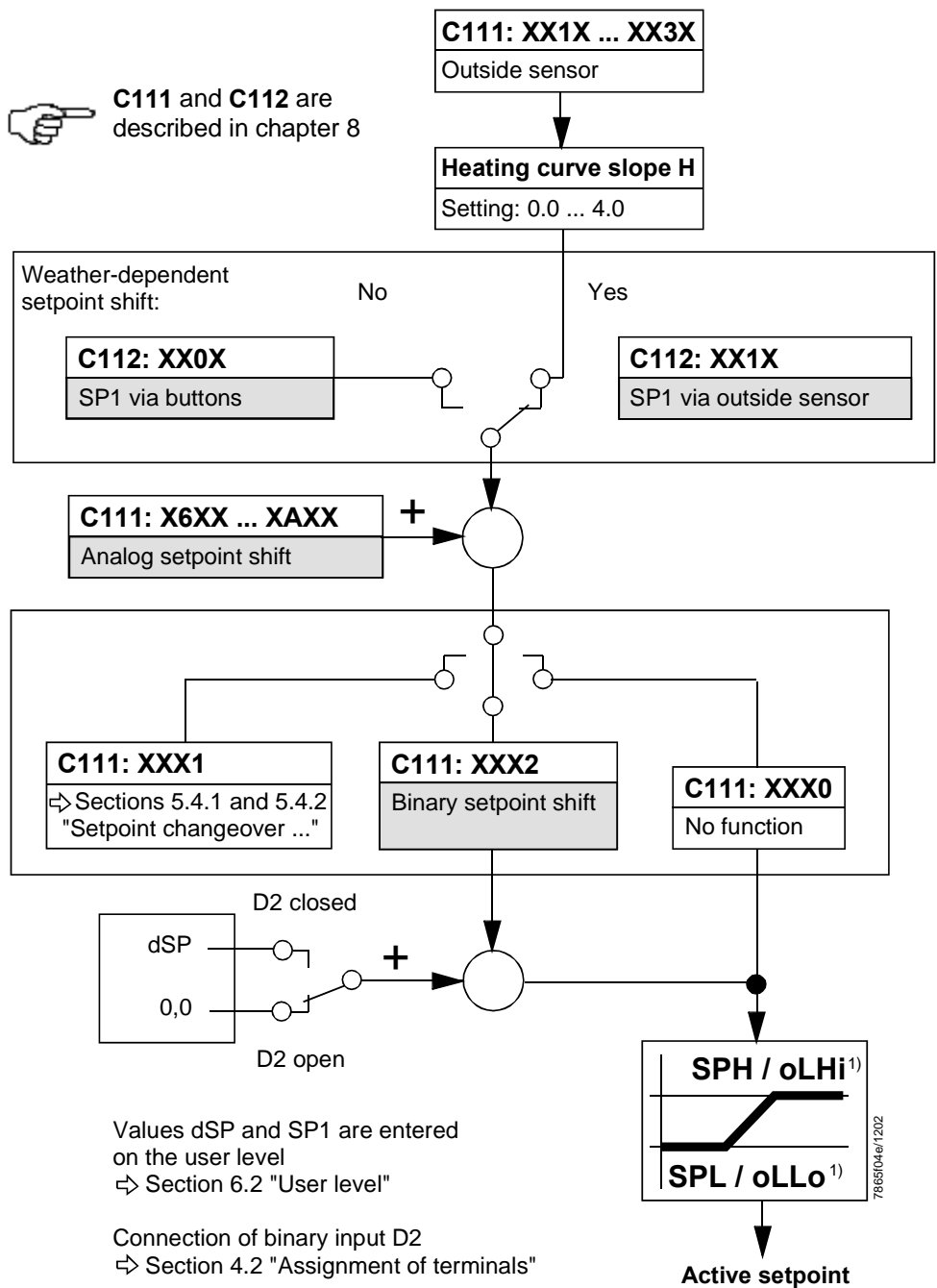

1) Only with RWF40.0X2B97

5.4.4 External setpoint, binary setpoint shift

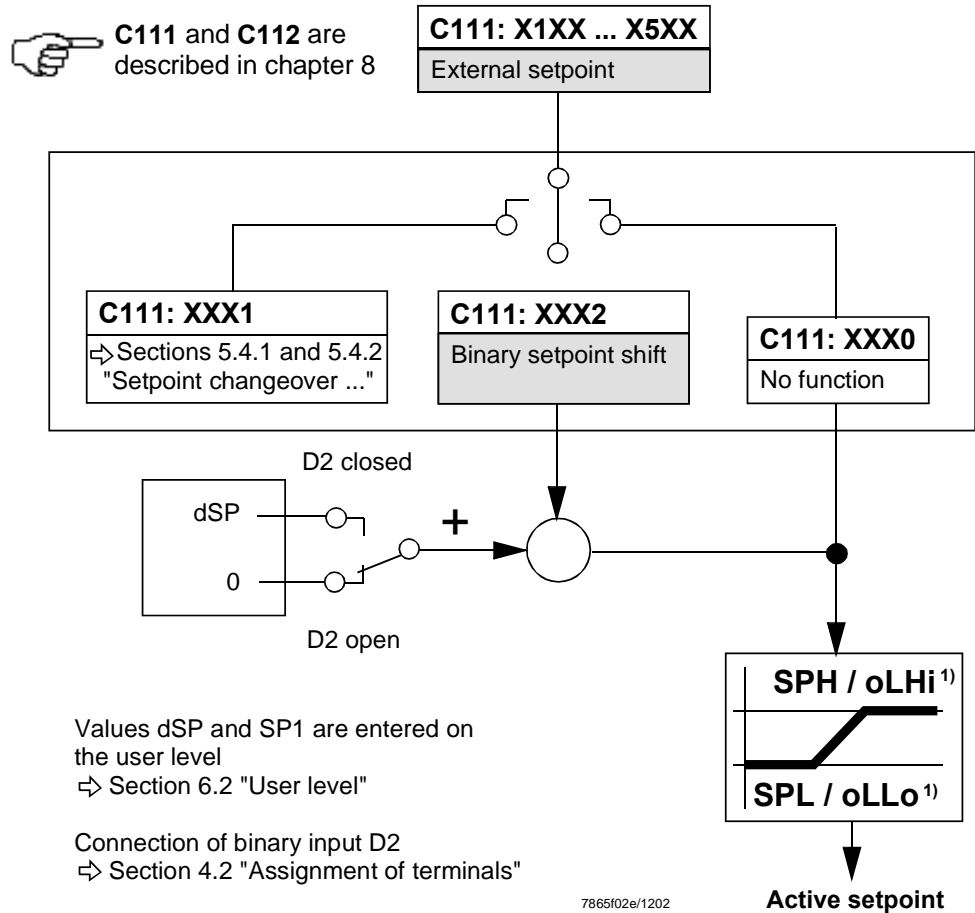

¹⁾ Only with RWF40.0X2B97

5.5 Weather-dependent setpoint shift

The RWF40... can be configured such that if an outside sensor with an LG-Ni1000 sensing element (e.g. QAC22...) is used, a weather-dependent setpoint shift will be implemented. The minimum and maximum setpoint values can be set by the lower setpoint limit «SPL» and the upper setpoint limit «SPH». In addition, with the RWF40.0X2B97, the lower working range limit «oLLo» and the upper working range limit «oLHi» protect the plant by ensuring that the minimum plant temperature will be observed. Parameter «P» can be used to apply a parallel displacement to the heating curve.



Each RWF40... must have its own separate outside sensor (no parallel connection)!



This function has been optimized for space heating combined with domestic hot water heating.

Parallel displacement of heating curve

⇒ Chapter 7 «Parameter settings»

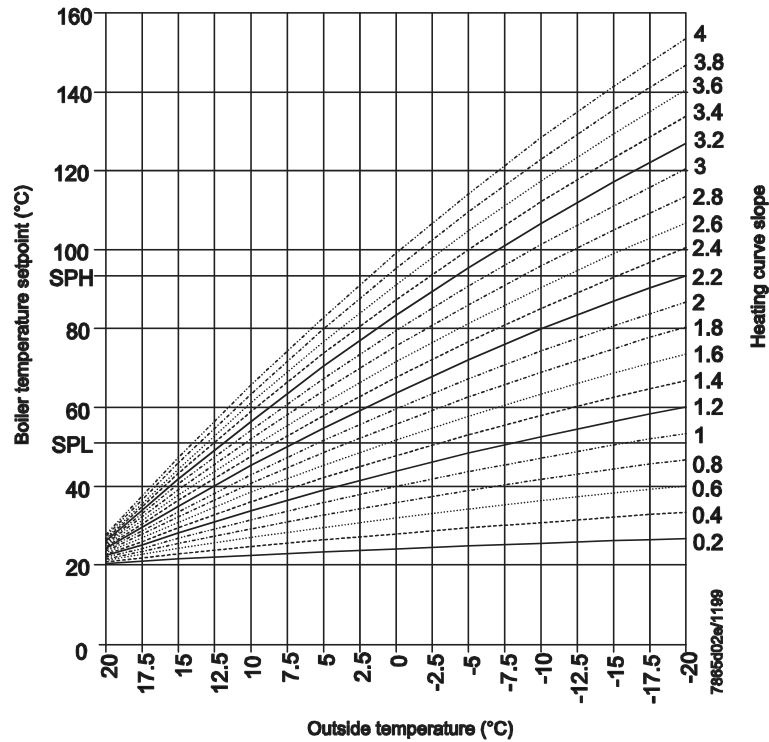

5.5.1 Heating curve slope

Slope «H» of the heating curve can be used to adjust the setpoint in response to the outside temperature, as shown in the diagram. The common origin of the heating curves is set at (20 °C / 20 °C). The effective range of the weather-dependent setpoint is restricted by the setpoint limits «SPH» and «SPL».

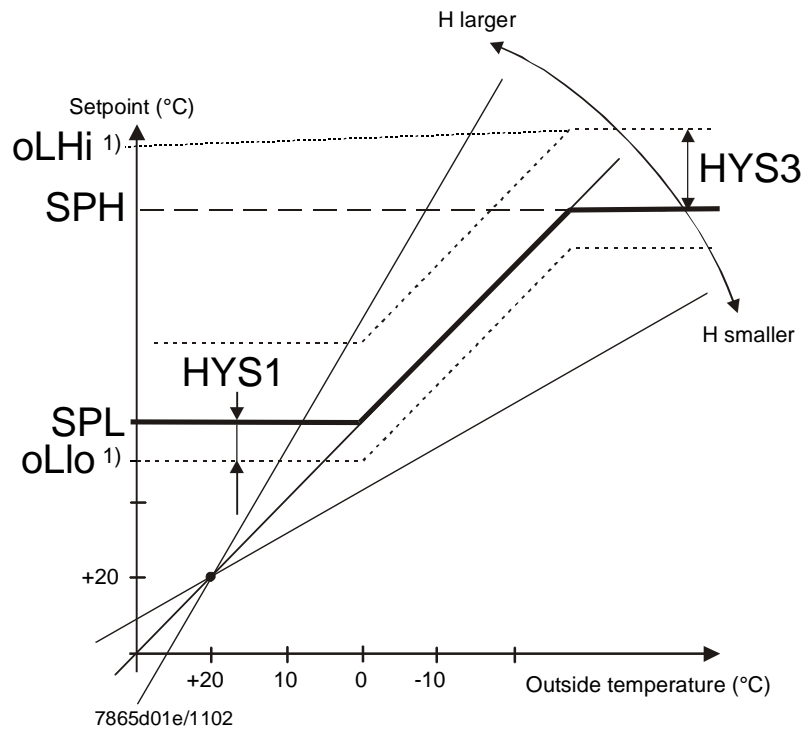

1) Only with RWF40.0X2B97

«HYS1» is the switch-on point for the burner, and «HYS3» is the switch-off point. As already described, they act with the set shift relative to the weather-dependent setpoint.

⇒ Section 5.2.1 «Modulating burner, floating output»

⇒ Section 5.2.2 «Modulating burner, analog output»

5.6 Response threshold «Q»

The response threshold «Q» defines for how long and how low the actual value is allowed to drop before the system switches to high-fire operation.

An internal mathematical calculation using an integration function determines the sum of all the areas $Q_{\text{eff}} = Q_1 + Q_2 + Q_3$, as shown in the diagram. This only takes place when the control deviation $(x-w)$ falls below the value of the switching threshold «HYS1». If the actual value increases, integration is stopped.

If « Q_{eff} » exceeds the preset response threshold «Q» (can be adjusted on the parameter level), this causes the second stage of the burner to switch on or - in the case of a floating controller / modulating controller – the actuating device to open.

If the actual boiler temperature reaches the required setpoint, Q_{eff} is reset to 0.

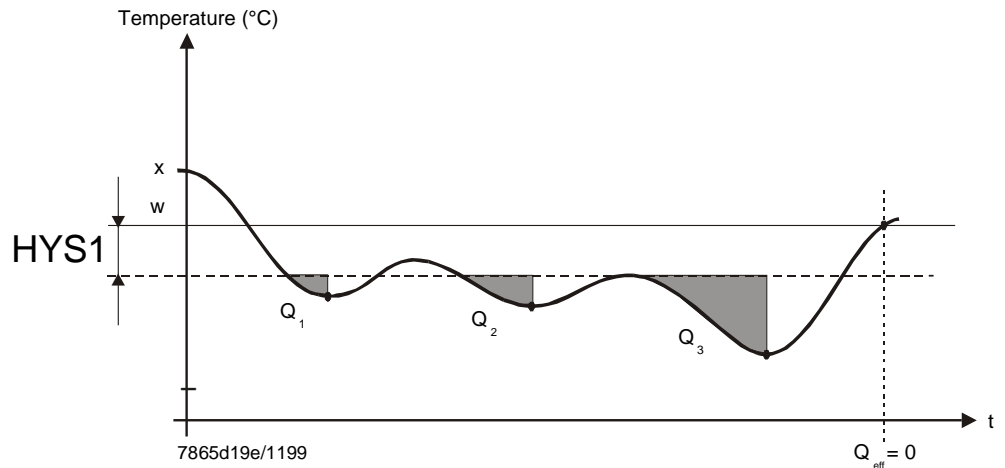

Monitoring of the actual value ensures that the switching frequency is kept low in the transitional range from low- to high-fire operation, aimed at reducing wear.

5.7 Cold start of the plant

When a heating system is switched off for a longer period of time, the actual value will drop of course.

To achieve a faster control response, the controller immediately starts in high-fire operation as soon as the control deviation ($x-w$) drops below a certain limit value. This limit is calculated as follows:

$$\text{Limit value} = 2 * (\text{HYS1} - \text{HYS3})$$

In that case, response threshold «Q» is inactive, independent of the operating mode and the controlled variable (temperature or pressure).

Example

Operating mode: Modulating, floating output

$$\text{HYS1} = -3 \text{ K}$$

$$\text{HYS3} = +5 \text{ K}$$

$$w = 60 \text{ }^\circ\text{C}$$

$$\text{Limit value} = 2 * (-3 - 5) = 2 * (-8) = -16 \text{ K}$$

At an actual value below $44 \text{ }^\circ\text{C}$, the heating up procedure immediately starts in high-fire operation, instead of in the thermostat mode.

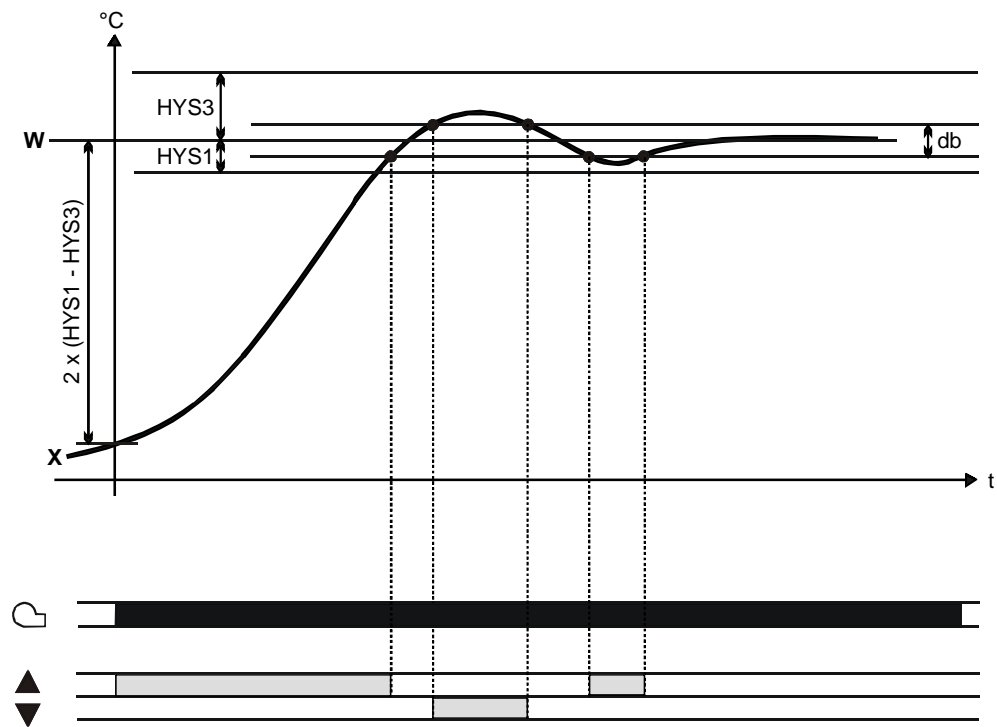

7865d20/1099

Assignment of levels

All levels can be accessed from the basic display via the **PGM** button, as shown in the diagram.

The upper actual value display (red) shows the actual value and the parameter values for the various levels.

The setpoint and parameters are shown in the lower section of the display (green).

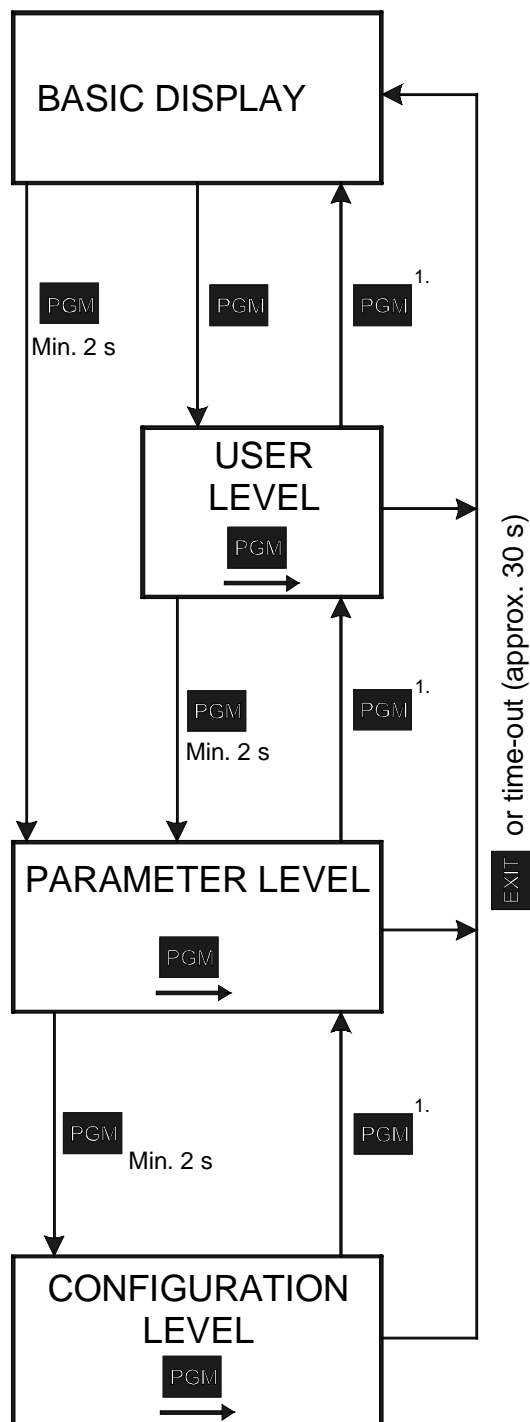

7865f08e/1299

¹⁾ After using **PGM** to step through all the parameters of a level, automatic return occurs after the last parameter has been confirmed.

6.1 Basic display

The diagram shows the RWF40... after switching power on. This condition is called the basic display. The actual value and the currently active setpoint are shown here. Manual operation, self-setting, the user, parameter and configuration levels can be activated from here.

6.1.1 Meaning of the display and buttons

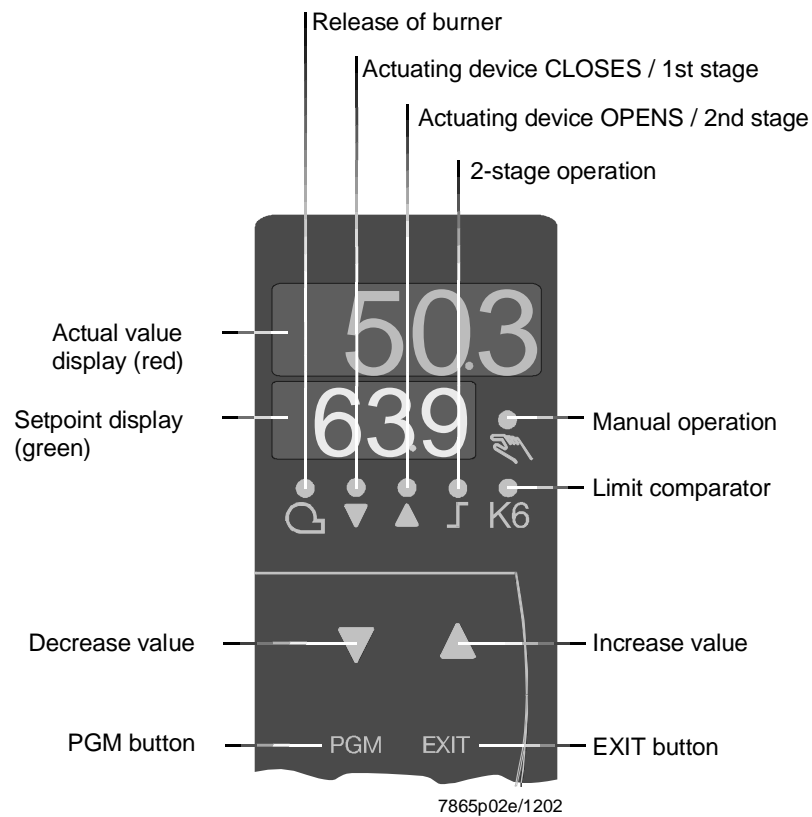

Initialization	All displays light up. The setpoint display flashes for about 10 seconds after switching power on.
Manual operation	The upper display shows the actual value. The LED for manual operation is on. Depending on the operating mode and the type of controller, the setpoint or the level of the manual actuator position is shown on the setpoint display (green). ⇒ Section 6.2.2 «Manual operation of a modulating burner»
Self-setting function	The actual value is shown on the actual value display (red) and the text « tunE » flashes on the setpoint display (green). ⇒ Section 9.1 «Self-setting function in high-fire operation»
Actual value display flashes	⇒ Chapter 10 «What to do if...»
2-stage operation	⇒ Section 5.2 «High-fire operation»
Time-out	 If there is no action by the operator, the controller will automatically return to the basic display after about 30 seconds.

6.2 User level

This level is started from the basic display. Setpoints «SP1» and «SP2 / dSP» can be altered, and the analog inputs «E2» (external setpoint / setpoint shift) and «E3» (outside temperature) can be displayed.

6.2.1 Changing the setpoints

To alter «SP1», «SP2» or «dSP»:

- * Change to the user level with 
- * Alter setpoint «SP1» with ▼ and ▲
- * Change to setpoint «SP2» or «dSP» with 
- * Alter setpoint «SP2» or «dSP» with ▼ and ▲
- * Return to the basic display with  or automatically via time-out after about 30 s

 After 2 seconds, the set value will automatically be adopted. The value can only change within the permitted value range

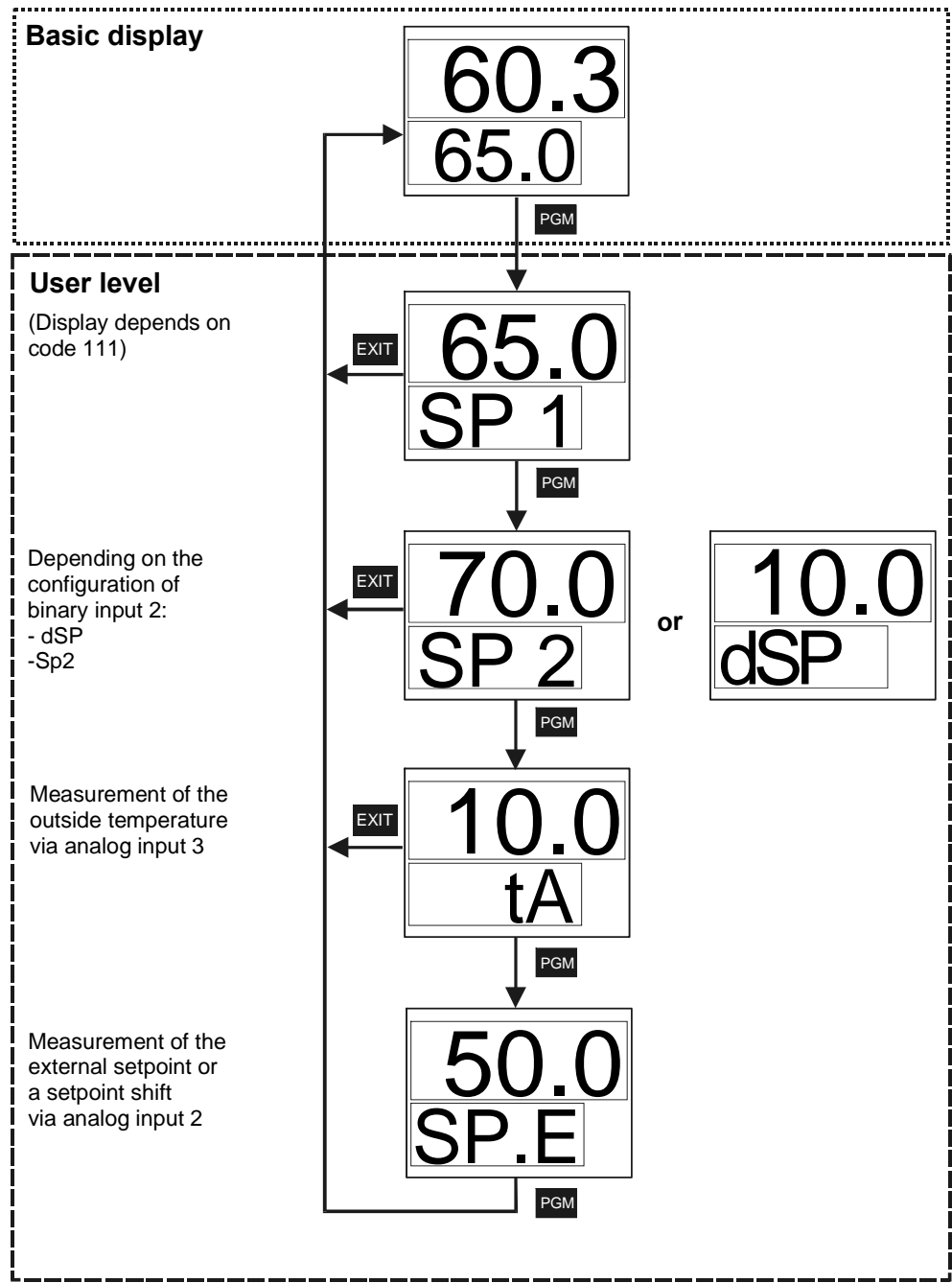

6.2.2 Manual operation, modulating burner

* Press  for 5 seconds

The LED above the hand symbol will light up.

Floating controller

* Change the position of the actuating device with ▲ and ▼

Relay 2 opens the actuating device as long as ▲ is kept depressed.

Relay 3 closes the actuating device as long as ▼ is kept depressed.

The LEDs for the actuating device indicate if «OPEN» or «CLOSE» is activated.

Modulating controller

* Change the position of the actuating device with ▲ and ▼

The analog output delivers the position of the actuating device that was entered.

* Return to automatic operation by pressing  for 5 seconds



When manual operation is activated, the position of the actuating device will be set to 0 until another entry with the buttons is made.

Thermostat mode

Manual operation can only be activated if the thermostat function has set relay 1 **active**. If the thermostat function sets relay 1 **inactive** during manual operation, manual operation is terminated.

6.2.3 Manual operation, 2-stage burner

* Press  for 5 seconds

* Press ▲ briefly

– Relay 2 is active, relay 3 is inactive

– Analog output (optional) delivers DC 10 V

The actuating device opens.

* Or press ▼ briefly

– Relay 2 is inactive, relay 3 is active

– Analog output (optional) delivers DC 0 V

The actuating device closes.

* Return to automatic operation by pressing  for 5 seconds



If the thermostat function sets relay 1 **inactive** during manual operation, manual operation is terminated.

6.2.4 Start self-setting

* Start self-setting with **PGM** + ▼

* Cancel with ▲

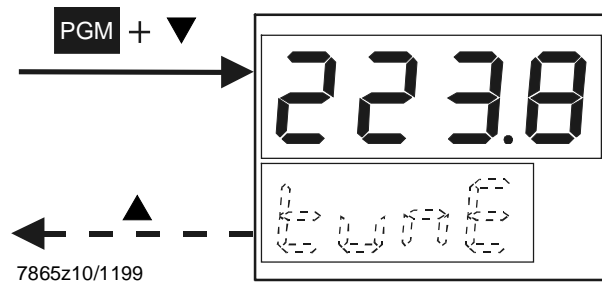

When «**tunE**» stops flashing, self-setting has stopped.

* Accept the parameters that have been determined by pressing ▲ (press the button for at least 2 seconds!)



It is not possible to start «**tunE**» in manual operation or thermostat operation.

6.2.5 Display of the software version and of unit of actual value

* Press **PGM** + ▲

Available units:

°C, °F and % (for standard signals)

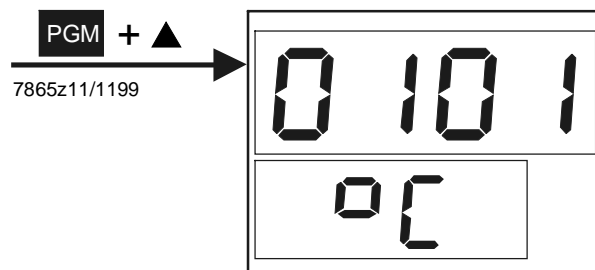

6.3 Parameter level

The parameters involved in adapting the controller to the controlled system are set here after the system has been started up.

Within the level, you can proceed to the next parameter by pressing .

 The display of the individual parameters depends on the type of controller.

6.3.1 Entering parameters Entry and alteration of the parameters is made through continuous alteration of the value. The longer you keep the button pressed, the faster the rate of change.

* Increase value by pressing ▲

* Decrease value by pressing ▼

* Accept entry by pressing 

or

* Cancel entry by pressing 

 After 2 seconds, the set value will automatically be accepted. The value can only change within the permissible value range.

⇒ Chapter 7 «Parameter settings»

6.4 Configuration level

The settings made here are those required for commissioning a specific installation and, therefore, need hardly ever be altered later on (acquisition of measured value or type of controller).

Within the level, you can advance to the next parameter by pressing .

6.4.1 Changing the configuration code

* Select position by pressing ▼ (position flashes!)

* Alter value by pressing ▲

* Accept code by pressing 

or

* Cancel entry by pressing 

⇒ Chapter 8 «Configuration»

7. Parameter settings

The parameter is shown on the lower setpoint display (green) and the parameter value on the upper / actual value display (red).

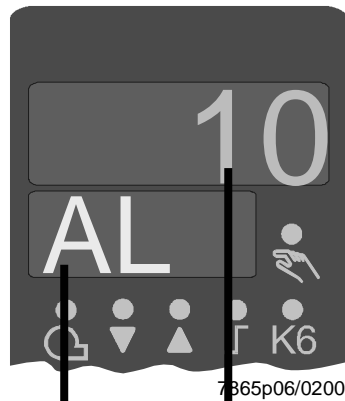

Parameter	Display	Value range	Factory setting	Remarks
Limit value for limit comparator ¹⁾	AL	-1999...+9999 digit	0	<p>⇒ Section 8.2 «C112 – limit comparator, controller type, setpoint «SP1», «locking»</p>
Switching differential for limit comparator ¹⁾	HYSt	0...999.9 digit	1	<p>Switching differential at the edges for the limit comparators</p> <p>⇒ Section 8.2 «C112 – limit comparator, controller type, setpoint «SP1», «locking»</p>
Proportional band ¹⁾	Pb.1	0.1...999.9 digit	10	Affects the P-response of the controller
Derivative time	dt	0...9999 s	80	<p>Affects the D-response of the controller. Within $dt = 0$, the controller has no D-response.</p> <p>For modulating controllers, $dt = rt / 4$ or 0 must be entered.</p>
Integral action time	rt	0...9999 s	350	Affects the I-response of the controller. With $rt = 0$, the controller has no I-response
Dead band (neutral zone) ¹⁾	db	0...999.9 digit	1	<p>For floating output</p>

¹⁾ Setting of the decimal place has an impact on this parameter.

7. Parameter settings

The parameter is shown on the lower / setpoint display (green) and the parameter value on the upper / actual value display (red).

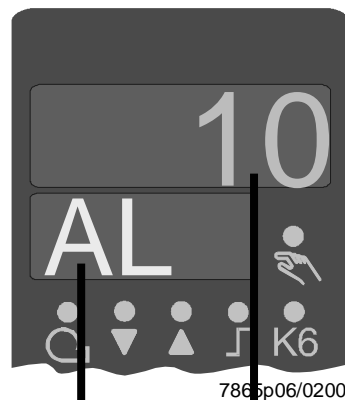

Parameter	Display	Value range	Factory setting	Remarks
Actuator running time	tt	10...3000 s	15 s	Running time of the valve for use with floating controllers
Switch-on threshold for burner stage II ¹⁾	HYS 1	0...-199.9 digit	-5	⇒ Section 5.5.1 «Heating curve slope»
Switch-off threshold stage II ¹⁾	HYS 2	0...HYS3 digit	3	⇒ Section 5.2 «High-fire operation»
Upper switch-off threshold ¹⁾	HYS 3	0...999.9 digit	5	⇒ Section 5.2 «High-fire operation»
Response threshold	q	0...999.9	0	⇒ Section 5.6 «Response threshold Q»
Heating curve slope	H	0...4	1	⇒ Section 5.5.1 «Heating curve slope»
Parallel displacement ¹⁾	P	-90...+90	0	⇒ Section 5.5 «Weather-dependent setpoint shift»

¹⁾ Setting of the decimal place has an impact on this parameter.



Note

When using the controller as a pure floating controller or modulating controller without the burner release function (Q13, Q14), parameter «HYS1» must be set to **0** and parameters «HYS2» and «HYS3» must be set to their **maximum** values.

→ Otherwise, e.g. when using default parameter «HYS1» (factory setting -5), the floating control loop will only be released when the control deviation reaches -5 K.

8.1 C111 inputs

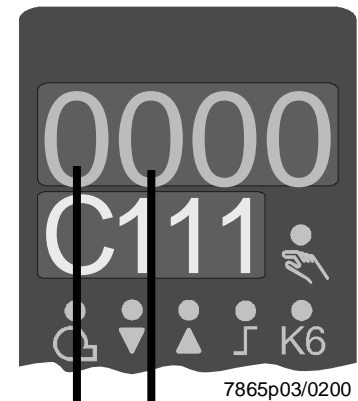

7865p03/0200

Analog input 1

Pt100, 3-wire, IEC 751	0
Pt100, 2-wire, IEC 751	1
Ni100, 3-wire, DIN 43760	2
Ni100, 2-wire, DIN 43760	3
Pt1000, 3-wire, IEC 751	4
Pt1000, 2-wire, IEC 751	5
Ni1000, 3-wire, DIN 43760	6
Ni1000, 2-wire, DIN 43760	7
LG-Ni1000, 3-wire	8
LG-Ni1000, 2-wire	9
NiCr-Ni / K	A
Cu-CuNi / T	b
NiCroSil-NiSil / N	C
Fe-CuNi / J	d
Standard signal DC 0...20 mA	E
Standard signal DC 4...20 mA	F
Standard signal DC 0...10 V	G
Standard signal DC 0...1 V	H
Pt-RhPt / S ¹⁾	i
Pt-RhPt / R ¹⁾	j
Pt-RhPt / B ¹⁾	L

Analog input 2

No function	0
External setpoint, 1 k Ω resistance potentiometer	1
External setpoint, DC 0...20 mA	2
External setpoint, DC 4...20 mA	3
External setpoint, DC 0...10 V	4
External setpoint, DC 0...1 V	5
Analog setpoint shift, 1 k Ω resistance potentiometer	6
Analog setpoint shift, DC 0...20 mA	7
Analog setpoint shift, DC 4...20 mA	8
Analog setpoint shift, DC 0...10 V	9
Analog setpoint shift, DC 0...1 V	A
Position feedback resistance potentiometer 1 k Ω ¹⁾	b
Position feedback 0...20 mA ¹⁾	C
Position feedback 4...20 mA ¹⁾	d
Position feedback 0...10 V ¹⁾	E
Position feedback 0...1 V ¹⁾	F

¹⁾ Only with RWF40.0X2B97

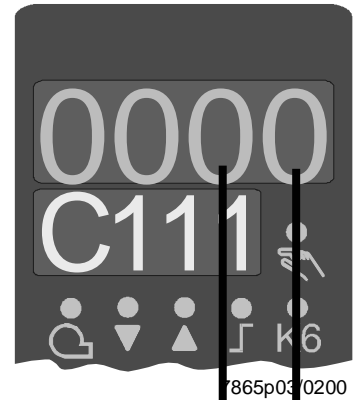

Analog input 3

No function	0
Outside sensor Pt1000, 2-wire, IEC 751	1
Outside sensor Ni1000, 2-wire, DIN 43760	2
Outside sensor LG-Ni1000, 2-wire	3

Function of binary input «D2»

No function	0
Setpoint changeover	1
Setpoint shift (binary)	2

Factory setting	9	0	3	0
------------------------	----------	----------	----------	----------

8.2 C112 limit comparator, controller type, setpoint «SP1», locking

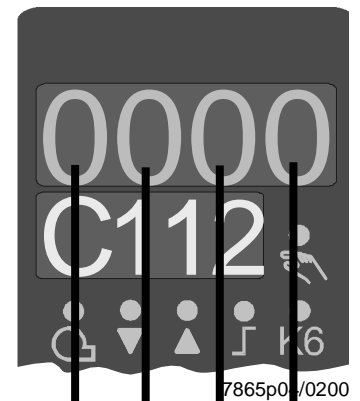

Limit comparator

No function (lk off)	0
lk1, input 1	1
lk2, input 1	2
lk3, input 1	3
lk4, input 1	4
lk5, input 1	5
lk6, input 1	6
lk7, input 1	7
lk8, input 1	8
lk7, input 2	9
lk8, input 2	A
lk7, input 3	b
lk8, input 3	C

Controller type

Floating controller	0
Modulating controller DC 0...20 mA	1
Modulating controller DC 4...20 mA	2
Modulating controller DC 0...10 V	3

Setpoint «SP1»

«SP1» via buttons	0
«SP1» with outside sensor (analog input 3 must be configured)	1

Locking

No locking	0
Locking of configuration level	1
Locking of parameter level	2
Locking of buttons	3



Locking of the buttons can be entered only **once** and adapted with **PGM**. Then, all button operations will be locked and can only be enabled again by the manufacturer!

Factory setting	0 0 1 0
------------------------	----------------

Function Ik1

Window function: Relay «K6» is active when the measured value lies within a window about the setpoint (w).

Example: $w = 80\text{ °C}$, $AL = 5$, $Hyst = 2$

Measured value rising: Relay «K6» switches on at 76 °C and off at 86 °C .

Measured value falling: Relay «K6» switches on at 84 °C and off at 74 °C .

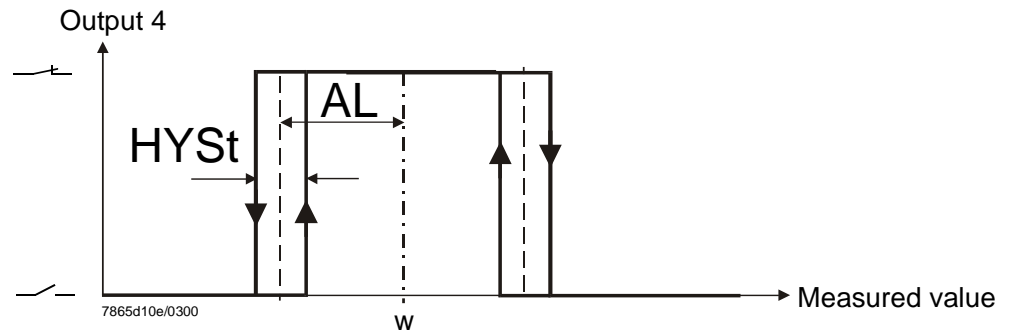

Function Ik2

Like Ik1, but inverted switching function.

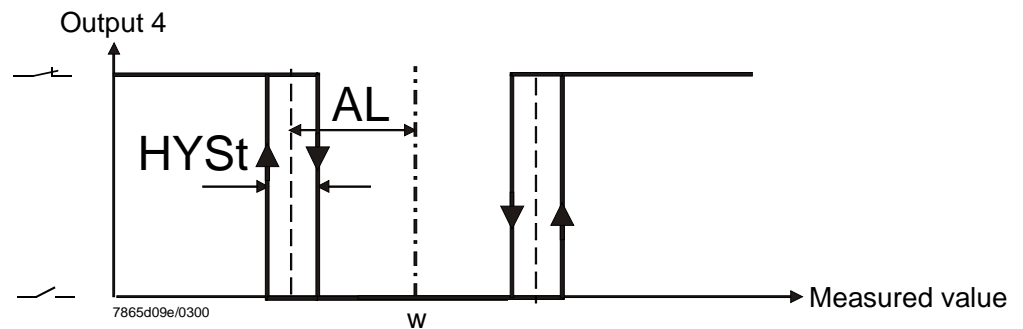

Hyst = switching differential of the window edges

AL = interval from setpoint (half the window-width)

Function Ik3

Lower limit signaling

Function: Relay inactive when measured value $<$ (setpoint – limit value).

Example: $w = 80\text{ °C}$, $AL = 10$, $Hyst = 2$

Measured value rising: Relay «K6» switches on at 71 °C .

Measured value falling: Relay «K6» switches off at 69 °C .

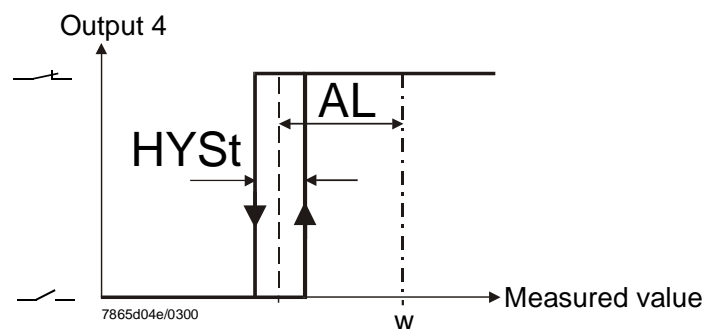

Function Ik4

Like Ik3, but inverted switching function.

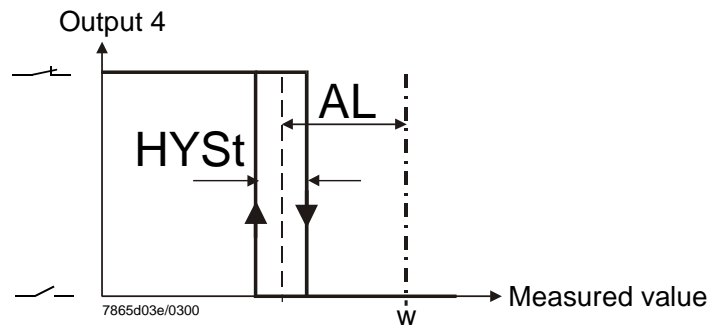

HYSt = switching differential

AL = interval from setpoint

⇒ Chapter 7 «Parameter settings»

Function Ik5

Upper limit signaling

Function: Relay inactive when measured value > (setpoint + limit value).

Example: $w = 80\text{ °C}$, **AL** = 10, **HYSt** = 2

Measured value rising: Relay «K6» switches off at 91 °C .

Measured value falling: Relay «K6» switches on at 89 °C .

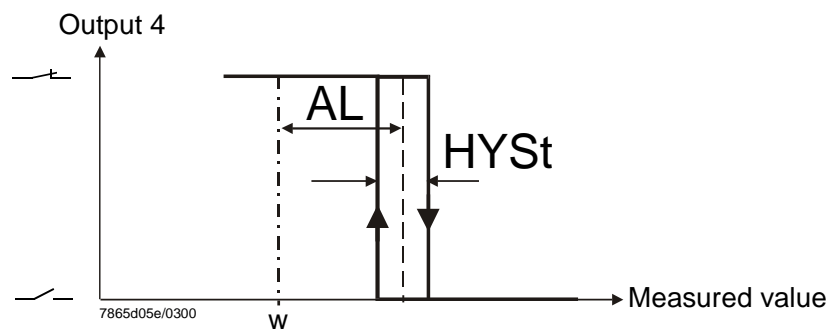

Function Ik6

Like Ik5, but inverted switching function.

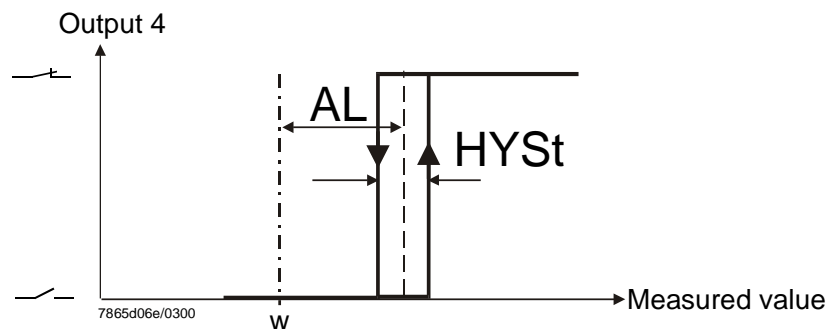

Function Ik7

The switching point is independent of the controller setpoint; only the limit value «AL» determines the switching point.

Function: Relay is active when value measured > limit value.

Example: **AL** = 50, **HYSt** = 2

Measured value rising: Relay «K6» switches on at 51 °C.

Measured value falling: Relay «K6» switches off at 49 °C.

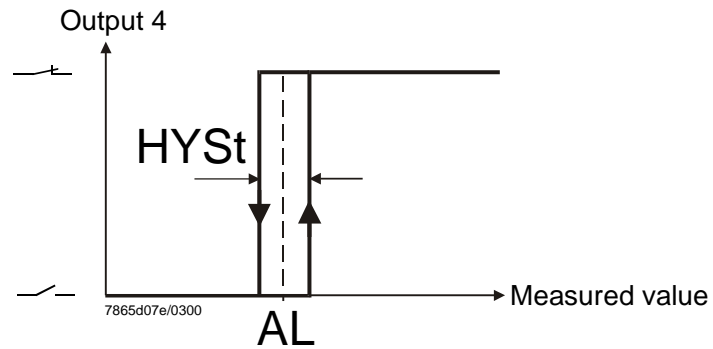

Function Ik8

Like Ik7, but inverted switching function.

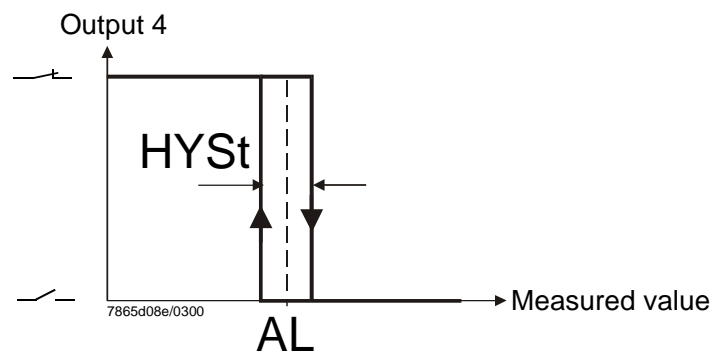

HYSt = switching differential

AL = limit value

⇒ Chapter 7 «Parameter settings»

8.3 C113 instrument address, dimensional unit, out-of-range



The setting of the decimal place has an impact on the parameters that are dependent on the actual value!

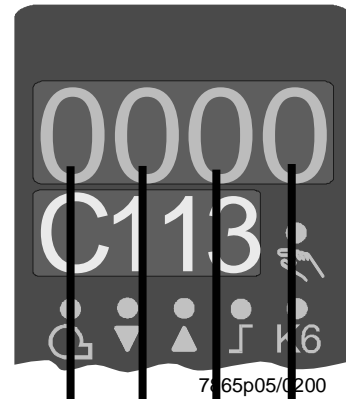

Unit address

Address 0	0	0
Address 1	0	1
...	...	
Address 99	9	9



Decimal place, unit, Baud rate

No decimal place, degrees Celsius, 9600 Bd	0
One decimal place, degrees Celsius, 9600 Bd	1
No decimal place, degrees Fahrenheit, 9600 Bd	2
One decimal place, degrees Fahrenheit, 9600 Bd	3
No decimal place, degrees Celsius, 19200 Bd ¹⁾	4
One decimal place, degrees Celsius, 19200 Bd ¹⁾	5
No decimal place, degrees Fahrenheit, 19200 Bd ¹⁾	6
One decimal place, degrees Fahrenheit, 19200 Bd ¹⁾	7
No decimal place, degrees Celsius, 4800 Bd ¹⁾	8
One decimal place, degrees Celsius, 4800 Bd ¹⁾	9
No decimal place, degrees Fahrenheit, 4800 Bd ¹⁾	A
One decimal place, degrees Fahrenheit, 4800 Bd ¹⁾	b

Signal for out-of-range

Limit comparators OFF	0
Limit comparators ON	1

Factory setting	0	1	1	0
------------------------	----------	----------	----------	----------

¹⁾ Only with RWF40.0X2B97

8.3.1 «SCL» scaling of standard signal range start, analog input 1

Example

SCL = 20; SCH = 100 °C

0 mA (start) corresponds to a measured value of 20 °C

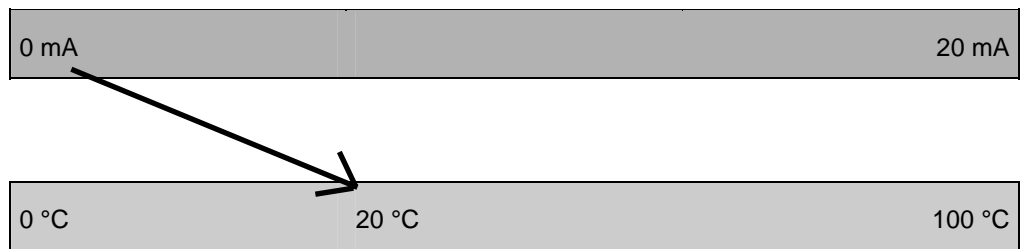

Value range: -1999...+9999 digit

Factory setting: 0 digit

8.3.2 «SCH» scaling of standard signal range end, analog input 1

Example

SCH = 80; SCL = 0 °C

20 mA (end) corresponds to a measured value of 80 °C

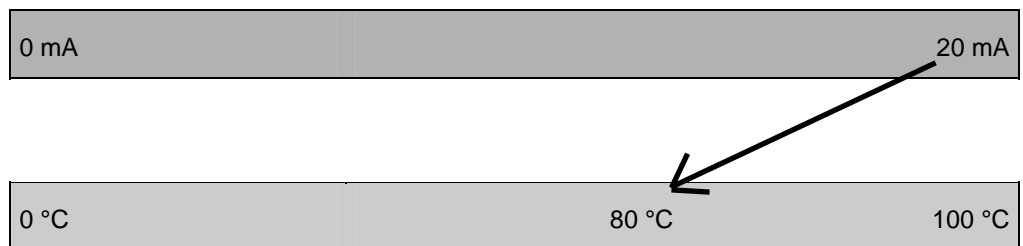

Value range: -1999...+9999 digit

Factory setting: 100 digit

8.3.3 «SCL2» scaling of standard signal range start, analog input 2

Example

SCL2 = 20:

0 mA corresponds to a measured value of 20 °C, as already described

Value range: -1999...+9999 digit

Factory setting: 0 digit

8.3.4 «SCH2» scaling of standard signal range end, analog input 2

Example SCH2 = 80:
20 mA corresponds to a measured value of 80 °C, as already described
Value range: -1999...+9999 digit
Factory setting: 100 digit

8.3.5 «SPL» lower setpoint limit

The controller restricts the setpoints to the set value.
Value range: -1999...+9999 digit
Factory setting: 0 digit

8.3.6 «SPH» upper setpoint limit

The controller restricts the setpoints to the set value.
Value range: -1999...+9999 digit
Factory setting: 100 digit

8.3.7 «OFF1» actual value correction for analog input 1

The actual value correction can be used for correction of the measured value upwards or downwards by a specific amount. It is also used for line compensation when resistance thermometers are connected in a 2-wire circuit.

Value range: -1999...+9999 digit
Factory setting: 0 digit

Example	Measured value	Offset	Displayed value
	294.7	+0.3	295
	295.3	-0.3	295

8.3.8 «OFF2» actual value correction for analog input 2

Value range: -1999...+9999 digit
Factory setting: 0 digit

8.3.9 «OFF3» actual value correction for analog input 3

Value range: -1999...+9999 digit
Factory setting: 0 digit

8.3.10 «dF1» 2nd order digital filter for analog input 1

Value range for filter time constant: 0...100 s
Factory setting: 1 second

8.3.11 «dF3» digital filter of 1st order for analog input 3 (only with RWF40.0X2B97)

Value range filter time constant: 0...1440 min
Factory setting: 1278 min

8.3.12 «oLLo» lower working range limit (only with RWF40.0X2B97)

The lower working range limit limits the control range in the downward direction. This limitation is independent of the setpoint adjustment and hysteresis 1. If switch-on threshold « $SP + Hyst1 < oLLo$ » falls below the lower working range limit, the switch-on threshold will be replaced by the lower working range limit. The setpoint does not change.

Example SP = 59 Hyst1 = -5 oLLo = 55

⇒ Switch-on threshold = 55
Current setpoint = 59

If the setpoint lies below the lower working range limit, the setpoint and switch-on threshold will be replaced by the lower working range limit.

Example SP = 54 Hyst1 = -5 oLLo = 55

⇒ Switch-on threshold = 55
Current setpoint = 55

As soon as supervision of the working range starts, «oL» and the current setpoint will flash alternately.

Value range: -1999...+9999 digit
Factory setting: -1999 digit

8.3.13 «oLHi» upper working range limit (only with RWF40.0X2B97)

The upper working range limit limits the control range in the upward direction. This limitation is independent of the adjustment of the setpoint and hysteresis 3. If switch-off threshold « $SP + Hyst3 > oLHi$ » exceeds the upper working range limit, the switch-off threshold will be replaced by the upper working range limit. The setpoint does not change.

Example SP = 90 Hyst3 = +5 oLHi = 93

⇒ Switch-off threshold = 93
Current setpoint = 90

If the setpoint lies above the upper working range limit, the setpoint and switch-off threshold will be replaced by the upper working range limit.

Example SP = 95 Hyst3 = +5 oLHi = 93

⇒ Switch-off threshold = 93
Current setpoint = 93

Value range: -1999...+9999 digit
Factory setting: 9999 digit

8.3.14 «dtt» bus watchdog timer for remote operation (only with RWF40.0X2B97)

In remote operation, bus communication is monitored (refer to User Documentation CC1A7865.1 RWF40... interface RS-485). Within the setting, communication with the management system must take place. If that is not the case, the RWF40... will automatically change from remote operation to local operation (operation like RWF40.0X0... and RWF40.0X1...).

Value range: 0...7200 s
Factory setting: 30 s
Exception: 0 = watchdog timer function deactivated

9.1 Self-setting function in high-fire operation

☞ «**tunE**» is only possible in high-fire operation, in the «modulating burner» mode.

The self-setting function «**tunE**» is a proper software function unit that is integrated into the controller. In the «modulating» mode, «**tunE**» tests the response of the controlled system to steps of the positioning signal according to a special procedure. A complex control algorithm uses the response of the controlled system (actual value) to calculate and store the control parameters for a PID or PI controller (set $dt = 0!$). The «**tunE**» procedure can be repeated any number of times.

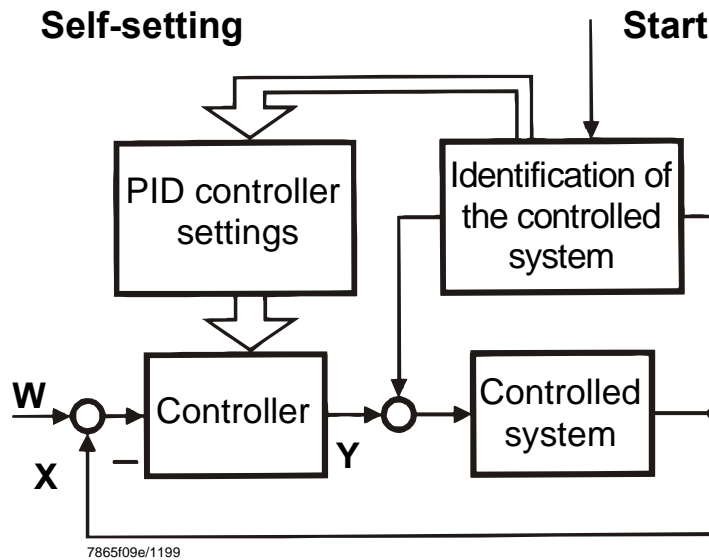

2 procedures

The «**tunE**» function uses 2 different methods that are automatically selected depending on the dynamic state of the actual value and the deviation from the setpoint at the start. «**tunE**» can be started from within any dynamic actual value sequence.

If there is a **large difference between actual value and setpoint** when «**tunE**» is activated, a switching line is established about which the controlled variable performs forced oscillations during the self-setting procedure. The switching line is set at such a level that the actual value should not exceed the setpoint.

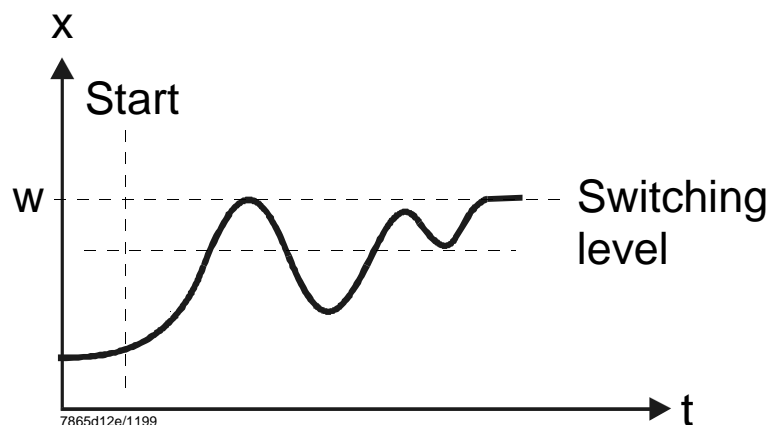

With a **small deviation** between setpoint and actual value (after the controlled system has stabilized, for instance), a forced oscillation is performed about the setpoint.

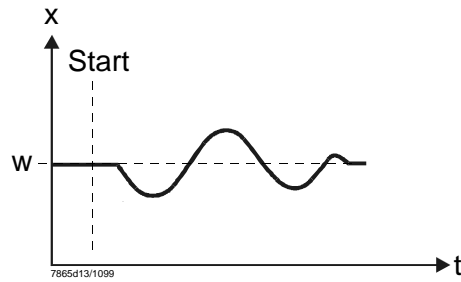

The controlled system data recorded for the forced oscillations are used to calculate the controller parameters «rt, dt, Pb.1» and a filter time constant for actual value filtering that is optimized for this controlled system.

Conditions

- High-fire operation in the «modulating burner» mode
- The thermostat function (relay 1) must be constantly activated, otherwise «**tunE**» will be canceled and no optimized controller parameters will be adapted
- The above mentioned actual value oscillations during self-setting must not exceed the upper threshold of the thermostat function (increase if necessary, and lower the setpoint)

9.2 Checking the controller parameters

The optimum adjustment of the controller to the controlled system can be checked by recording a startup sequence with the control loop closed. The following diagrams indicate possible incorrect adjustments, and their correction.

Example

The response to a setpoint change is shown here for a 3rd order controlled system for a PID controller. The method used for adjusting the controller parameters can, however, also be applied to other controlled systems.

A favorable value for «dt» is «rt» / 4.

«PB too small»

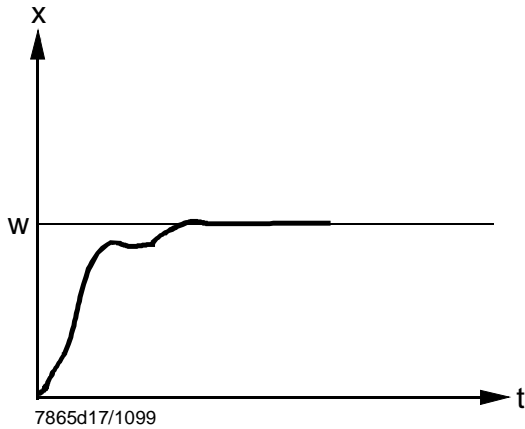

«PB too large»

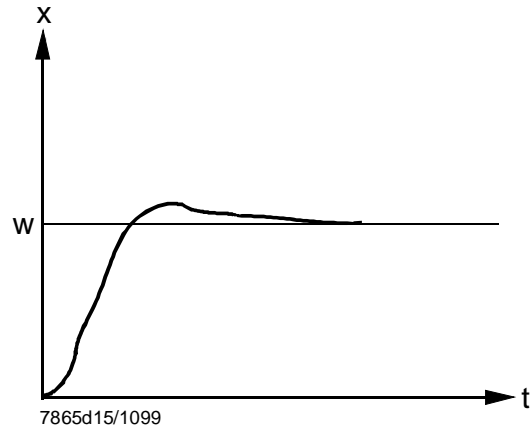

«rt, dt» too small

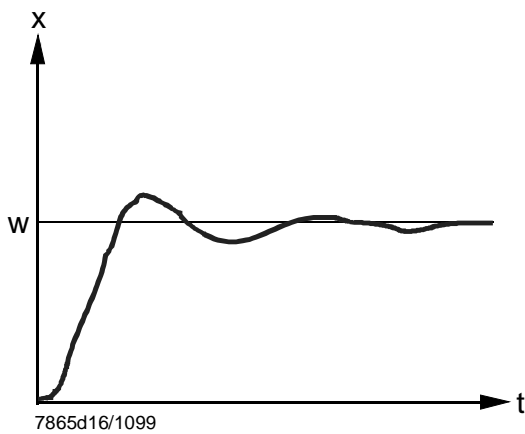

«rt, dt» too large

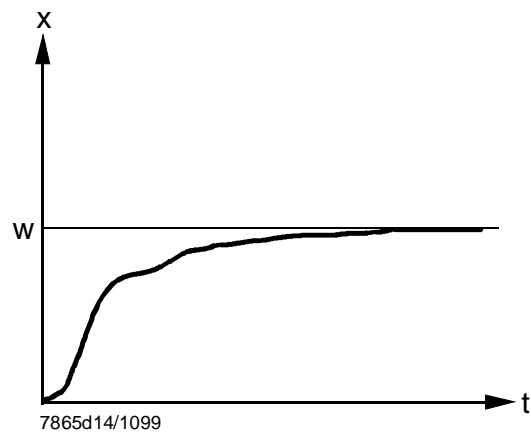

Optimum adjustment

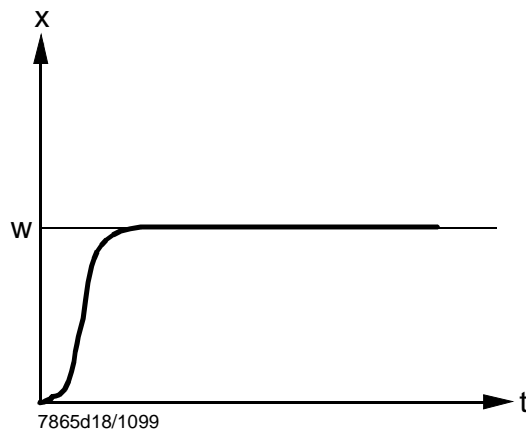







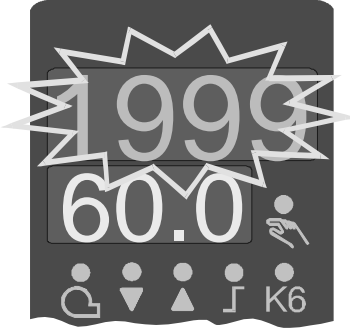

10.1 ...numbers are flashing on the display

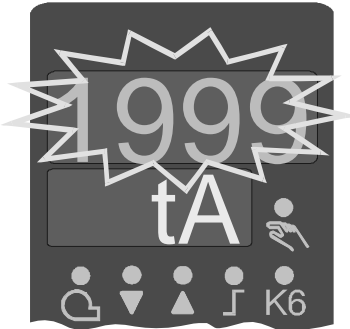
This is an indication of incorrect measured value acquisition.

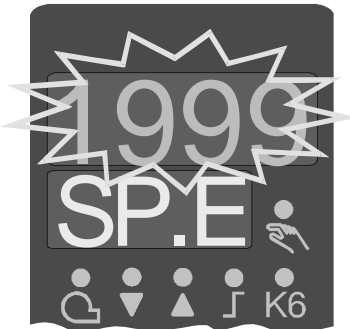
 Detection of measured value range crossings depends on the type of sensor used.

⇒ Section 11.3.2 «Measured value circuit monitoring»

Display	Description		Cause / controller behavior / remedy
 <p style="text-align: right; font-size: small;">7865p08/0200</p>	<p>Actual value display (red) shows «1999» flashing. Setpoint display shows the setpoint.</p>		<p>Overrange or underrange on analog input 1. Actual value is not measured. Controller initiates lockout. ⇒ Section 5.3 «Safety shutdown»</p> <p>The limit comparator responds to analog input 1 according to the configuration (C113).</p> <p>* Check electrical connections for open-circuit of sensor</p>
 <p style="text-align: right; font-size: small;">7865p10/0200</p>	<p>When analog input 3 is configured for outside temperature (C111) and the measured value is called up, the actual value display (red) shows «1999» flashing.</p>		<p>Overrange or underrange on analog input 3. Outside temperature is not measured! The weather-dependent setpoint is inactive!</p> <p>* Check electrical connections for open-circuit of sensors</p>
 <p style="text-align: right; font-size: small;">7865p09/0200</p>	<p>When analog input 2 is configured (C111) and the measured value is called up, the process value display (red) shows «1999» flashing.</p>		<p>Overrange or underrange on analog input 2. External setpoint is not measured. Controller initiates lockout ⇒ Section 5.3 «Safety shutdown»</p> <p>* Check electrical connections for open-circuit of sensors</p>
 <p style="text-align: right; font-size: small;">7865p07/0200</p>	<p>Actual value display (red) shows «XXXXXX». Setpoint display (green) shows «1999» flashing.</p>		<p>Overrange or underrange on analog input 2. Setpoint shift is not measured. Controller initiates lockout ⇒ Section 5.3 «Safety shutdown»</p> <p>* Check electrical connections for open-circuit of sensor</p>

11.1 Inputs

11.1.1 Analog input 1 (actual value)

For resistance thermometers, thermocouples or standard signals with 2nd order digital filter (configurable).

Resistance thermometers In 2-wire or 3-wire circuit:

Type	Measured value range
Pt100, Pt1000, IEC 751	-200...+850 °C (-328...+1562 °F)
Ni100, Ni1000, DIN 43760	-60...+250 °C (-76...+482 °F)
LG-Ni1000	-50...+160 °C (-58...+320 °F)

Line resistance: < 30 Ω

Line compensation

Not required with 3-wire circuit.

When using a resistance thermometer in a 2-wire circuit, line compensation can only be made by means of the offset correction.

Thermocouples

Type	Measured value range
Fe-CuNi «J»	-200...+1000 °C (-328...+1832 °F)
NiCr-Ni «K»	-200...+1372 °C (-328...+2502 °F)
Cu-CuNi «T»	-200...+400 °C (-328...+752 °F)
NiCrSi-NiSi «N»	-100...+1300 °C (-148...+2372 °F)
Pt-RhPt «S»	0...1768 °C (-32...3214 °F) ¹⁾
Pt-RhPt «R»	0...1768 °C (-32...3214 °F) ¹⁾
Pt-RhPt «B»	0...1820 °C (32...3308 °F) ¹⁾

¹⁾ Only with RWF40.0X2B97

Cold-junction temperature: Internal

Standard signals

Signal	Internal resistance R_i Voltage drop ΔU_e
DC 0...10 V	$R_i = 2 \text{ M}\Omega$
DC 0...1 V	$R_i = 2 \text{ M}\Omega$
DC 0...20 mA	$\Delta U_e = < 1 \text{ V}$
DC 4...20 mA	$\Delta U_e = < 1 \text{ V}$

Sampling time: 210 ms

11.1.2 Analog input 2 (external setpoint, setpoint shift)

Resistance measured value 0...1 kΩ standard signals without linearization.

Potentiometer

With 2-wire circuit

$R = 0...1 \text{ k}\Omega$

Standard signals

Signal	Internal resistance R_i Voltage drop ΔU_e
DC 0...10 V	$R_i = 2 \text{ M}\Omega$
DC 0...20 mA	$\Delta U_e = 1 \text{ V}$
DC 4...20 mA	$\Delta U_e = 1 \text{ V}$

Sampling time: 630 ms

11.1.3 Analog input 3 (outside temperature)

For resistance thermometers in a 2-wire circuit, with fixed filter time constants (21 h 18 min for weather-dependent setpoint enable)

Resistance thermometer

Type	Measured value range
Pt1000, IEC 751	-200...+850 °C (-328...+1562 °F)
Ni1000, DIN 43760	-60...+250 °C (-76...+482 °F)
LG-Ni1000	-50...+160 °C (-58...+320 °F)

Sampling time: 6 seconds

11.1.4 Binary input «D1»

Potential-free contact for changeover of operating mode:
 – Modulating burner, when contact is open, LED on the front is not lit
 – 2-stage burner, when contact is closed, LED on the front is lit

11.1.5 Binary input «D2»

Potential-free contact for the following functions, depending on the configuration:
 – No function
 – Setpoint shift
 – Setpoint changeover

11.2 Outputs

4 relay outputs, 1 analog output (optional) and a transducer supply are provided as standard.

11.2.1 Output 1 (release of burner)

Relay output (N.O. contact)

Contact rating: AC 24...240 V, 2 A at p.f. (cos φ) > 0.6
Contact life: > 2 x 10⁵ switching cycles at rated load
Internal contact protection: Varistor S07K275

11.2.2 Output 2, 3 (floating output)

2 relay outputs (N.O. contacts) with a common pole, for actuating device open / close

Contact rating: AC 24...240 V, 2 A at cos φ > 0.6
Contact life: > 2 x 10⁵ switching cycles at rated load
Internal contact protection: RC combination (C = 2.5 nF, R = 100 Ω)

11.2.3 Output 4 (limit comparator)

Relay output (N.O. contact)

Contact rating: AC 24...240 V, 2 A at cos φ > 0.6
Contact life: > 2 x 10⁵ switching cycles at rated load
Internal contact protection: Varistor S07K275

11.2.4 Output 5, analog output (option)

Analog output, electrically isolated from the analog inputs:
 $\Delta U < AC\ 30\ V$, $\Delta U < DC\ 50\ V$

Standard signals	Load, burden
DC 0...10 V (short-circuit proof)	Load = > 500 Ω
DC 0...20 mA	Burden = < 500 Ω
DC 4...20 mA	Burden = < 500 Ω

Accuracy: $\pm 0.25\ % \pm 50\ \text{ppm} / K$

11.2.5 Transducer supply

DC 24 V, 30 mA (short-circuit proof)

11.2.6 Interface RS-485 (optional)

Baud rate: 4,800, 9,600 or 19,200
Protocol: MOD bus
Unit address: 1...99

Galvanic separation between supply voltage, analog inputs and outputs.

⇒ Section 4.3 «Galvanic separation»

11.3 General ratings

Weight: approx. 430 g
Data backup: EEPROM
Operating voltage: AC 100...240 V $\pm 10\ %$, 48...63 Hz
Power consumption: approx. 5 VA
Electrical connection: at the rear, via plug-in screw terminal strips, angled at 45°
Electrical safety: to EN 60730
Case: mounting depth 130 mm
plastic body with rear panel, self-extinguishing
flammability class: UL94 V0
seal between case and control panel

11.3.1 Measuring accuracy

Resolution: > 15 bit

Measuring accuracy	Ambient temperature error
Resistance thermometer:	
≤ 0.05 %	≤ 50 ppm / K
Thermocouples:	
≤ 0.25 %	≤ 100 ppm / K
Standard signals:	
≤ 0.1 %	≤ 100 ppm / K

Values include linearization tolerances.

11.3.2 Monitoring of measuring circuit

Transducer	Probe break	Short-circuit
Resistance thermometer	X	X
Thermocouples	X	-
DC 0...10 V	-	-
DC 0...20 mA	-	-
DC 4...20 mA	X	X

- = is **not** detected

X = is detected, and «-1999» appears on the display

⇒ Chapter 10 «What to do if...»

11.3.3 Environmental conditions

Permissible ambient temperature range:

-20...+50 °C

Permissible storage temperature range:

-40...+70 °C

Climatic conditions:

Relative humidity ≤ 95 % (noncondensing)

Degree of protection to EN 60529:

Front IP 65

Rear IP 20

Electromagnetic compatibility (EMC):

To NAMUR recommendation NE 21, EN 50 081 part 1, EN 50 082 part 2

12. Actual settings

12.1 Process data

Parameter	Display	Value range	Factory setting	Setting
Setpoint 1 ¹⁾	SP1	SPL-SPH	0	
Setpoint 2 (option) ¹⁾	SP2	SPL-SPH	0	
Digital setpoint shift (optional) ¹⁾	dSP	SPL-SPH	0	
Outside temperature (optional)	TA	⇒ Section 8.1 «C111 inputs»	-	
Predefinition of external setpoint ¹⁾	SP.E	SPL-SPH	-	

¹⁾ Setting of the decimal places has an impact on these parameters

12.2 Parameter level

Parameter	Display	Value range	Factory setting	Setting
Limit value of limit comparator ¹⁾	AL	-1999...+9999 digit	0	
Switching differential for limit comparator ¹⁾	HYS t	0...999.9 digit	1	
Proportional band ¹⁾	Pb.1	0.1...999.9 digit	10	
Derivative time	dt	0...9999 s	80	
Integral action time	rt	0...9999 s	350	
Dead band (neutral zone) ¹⁾	db	0...999.9 digit	1	
Actuator running time	tt	10...3000 s	15 s	
Switch-on threshold burner / stage II ¹⁾	H Y S 1	0...-199.9 digit	-5	
Switch-off level stage II ¹⁾	H Y S 2	0... HYS3 digit	3	
Upper switch-off threshold ¹⁾	H Y S 3	0...999.9 digit	5	
Response threshold	q	0...999.9	0	
Heating curve slope	H	0...4	1	
Parallel displacement ¹⁾	P	-90...+90	0	

¹⁾ Setting of the decimal place has an impact on these parameters

12.3 Configuration level

Parameter	Display	Factory setting	Setting
Analog input 1, 2 and 3; setpoint changeover / shift	C111	9030	
Limit comparator; controller type; setpoint 1; locking	C112	0010	
Unit address; decimal place / unit, signal for out-of-range	C113	0110	
Measured value range start analog input 1 ^{1.}	SCL	0	
Measured value range analog input 1 ^{1.}	SCH	100	
Measured value range analog input 2 ^{1.}	SCL2	0	
Measured value range analog input 2 ^{1.}	SCH2	100	
Lower setpoint limit ^{1.}	SPL	0	
Upper setpoint limit ^{1.}	SPH	100	
Actual value correction, analog input 1 ^{1.}	OFF1	0	
Actual value correction, analog input 2 ^{1.}	OFF2	0	
Actual value correction, analog input 3 ^{1.}	OFF3	0	
Filter time constant for digital filter, analog input 1	dF1	1	
Filter time constant for digital filter, weather-dependent setpoint shift	dF3 ^{2.}	1278	
Lower working range limit ^{1.}	oLLo ^{2.}	-1999	
Upper working range limit ^{1.}	oLHi ^{2.}	9999	
Bus watchdog timer	dtT ^{2.}	30	

^{1.} Setting of the decimal place has an impact on these parameters

^{2.} Only with RWF40.OX2B97

**Siemens Building Technologies
Production GmbH**

Berliner Ring 23

D - 76347 Rastatt

Tel. 0049 - 7222 - 598 - 0

Fax. 0049 - 7222 - 598 269

<http://www.sbt.siemens.com>

© 2005 Siemens Building Technologies Production GmbH
Subject to change!

SIEMENS

Represented By:
POWER EQUIPMENT COMPANY
2011 Williamsburg Road
Richmond, VA 23231
Ph. 804-236-3800
Fx. 804-236-3882
www.peconet.com